



WS-400/500B LITE SERIES SPIN PROCESSOR

OPERATION MANUAL

P/N 10070021F5
APRIL 25, 2005 pg/kv
Starting ~S/N: 04460

441 Industrial Drive
North Wales, PA 19454
215-699-7278

sales@laurell.com
support@laurell.com
www.laurell.com

FEATURES

- Solid state electronics - microprocessor control
- Permanent EEPROM storage of programs and setup
- Ability to store multiple programs
- Closed loop motor control
- Vacuum substrate hold-down interlock with adjustable setpoint
- Lid closure interlock
- Door-latch on 8 and 15 series
- Motor seal purge interlock (Nitrogen or Clean Dry Air is required)
- Automatic power reduction (sleep mode) after ~10 minutes of non-use
- Step time resolution of 0.1 second
- Time, rpm, and acceleration / deceleration programmable per step
- Password protected program lock and skip step
- Quality guaranteed – 100% manufactured and assembled in U.S.A.
- Warranty - 1 year on parts and service – see quotation for all terms and conditions

TABLE OF CONTENTS

<u>SECTION</u>	<u>PAGE NO.</u>
FEATURES	2
SECTION 1 – HEALTH,SAFETY AND ENVIRONMENTAL	6
1.1 LAURELL TECHNOLOGIES ENVIRONMENTAL, HEALTH AND SAFETY POLICY	7
1.2 HAZARD WARNINGS	7
1.2.1 LEVEL OF HAZARD INTENSITY.....	8
1.2.2 HAZARD PICTOGRAMS.....	9
1.2.3 HAZARD AVOIDANCE TEXT	10
1.3 EMERGENCY SHUTDOWN OPTION (station installations only)	10
1.3.1 EMO (Emergency Machine Off) PROCEDURE.....	11
1.4 PROTECTIVE APPAREL	11
1.5 POTENTIAL EXPOSURE HAZARDS	12
1.5.1 ELECTRICAL HAZARDS	12
1.5.2 STATIC ELECTRICITY: BONDING AND GROUNDING	13
1.5.2.1 BONDING	13
1.5.2.2 GROUNDING.....	13
1.5.3 MOVING PARTS HAZARDS	14
1.5.4 AUDIO NOISE HAZARDS	14
1.5.5 CHEMICAL HAZARDS AND COMPATIBILITY	14
1.5.6 SOLVENTS	15
1.5.7 ISOPROPYL ALCOHOL - Example	16
1.5.8 HYDROGEN PEROXIDE - Example	16
1.5.9 SULFURIC ACID - Example	17
1.5.10 HAZARDOUS WASTE	17
1.5.11 CHEMICAL DISPOSAL	18
1.5.12 ADDITIONAL SAFETY PRECAUTIONS.....	18
1.6 ENVIRONMENTAL	20
1.6.1 MATERIAL SAFETY DATA SHEETS	20
1.6.2 MIXING INCOMPATIBLE CHEMICALS.....	20
1.6.3 RECOMMENDED ABATEMENT TECHNOLOGY	21
1.6.4 LOCAL RESTRICTIONS (example)	21
SECTION 2 - INSTALLATION	23
2.1 FACILITY REQUIREMENTS	23
2.1.1 FACILITIES	23
2.1.2 SPIN PROCESSOR POWER REQUIREMENTS	23
2.1.3 MAIN CIRCUIT BREAKER.....	23
2.1.4 DIMENSIONS.....	23
2.1.5 AMBIENT TEMPERATURE.....	23
2.1.6 SPIN PROCESSOR CHAMBER PRESSURE.....	24

2.1.7 DISPENSE LIQUIDS.....	24
2.1.8 EXHAUST REQUIREMENTS	24
2.1.9 VACUUM PUMP (OPTION).....	24
2.1.10 SECONDARY CONTAINMENT AND SPILL PREVENTION FEATURES.....	24
2.2 INSTALLATION	25
2.2.1 SPIN PROCESSOR'S CONNECTIONS.....	25
2.2.1.1 COMPRESSION FITTING ASSEMBLY	26
2.2.2 TYPICAL INSTALLATION DRAWING Figure # 2-1	27
2.2.3 DRAIN AND EXHAUST CONNECTION	28
2.2.4 INDECK CONNECTIONS	30
SECTION 3 - OPERATION	31
3.1 POWER	32
3.2 INTERLOCKS	32
3.2.1 LID INTERLOCK.....	32
3.2.2 VACUUM INTERLOCK.....	33
3.2.3 SEAL PURGE INTERLOCK.....	34
3.2.4 POWER ON LID CHECK.....	34
3.3 KEYPAD.....	35
3.3.1 OPERATIONAL KEYS	36
3.4 THE LCD DISPLAY.....	38
3.4.1 LINE ONE OF LCD DISPLAY	39
3.4.2 LINE TWO OF LCD DISPLAY.....	40
3.4.3 LINE THREE OF LCD DISPLAY- SET POINT VALUES.....	40
3.4.4 LINE FOUR OF LCD DISPLAY – ACTUAL VALUES	41
3.5 PROGRAMMING.....	41
3.5.1 PROGRAMMING ACCELERATION/DECELERATION.....	42
3.6 NORMAL OPERATION (“OFF/RUN” MODE).....	43
3.7 REMOVING/CHANGING CHUCKS	44
3.7.1 SCREW ON TYPE CHUCK	44
3.7.2 BOLT ON TYPE CHUCK.....	44
3.8 SOFTWARE VERSION	46
3.9 HIGH PERFORMANCE DRIVE MOTOR (HPD).....	46
3.9.1 PROGRAMMING THE HPD	46
SECTION 4 - MAINTENANCE.....	49
4.1 ERROR MESSAGES	50
4.1.1 VACUUM LOSS.....	51
4.1.2 REMOVING, CLEANING AND INSTALLING THE VACUUM VALVE	51
4.1.3 VACUUM CHUCK WET TEST	54
4.1.4 REMOVING, CLEANING AND REPLACING THE VACUUM CHUCK O-RING	55
4.1.4.1 O-RING COMPOSITION, USES AND RECOGNITION	56
4.1.5 MOTOR OPERATION.....	57
4.1.6 MOTOR CALIBRATION	57

SECTION 5 - APPENDIX	59
5.1.1 INSTALLATION WS-400 6&8 LITE	59
5.1.2 INSTALLATION RD-100, WS-400 6&8 LITE INDECK	60
5.1.3 INSTALLATION INDECK CONTROLL PANEL	61
5.1.4 INSTALLATION TUBING FOR INDECK	62
5.2 AVAILABLE OPTIONS	63
5.3 WORKSHEETS	64

SECTION 1 – HEALTH, SAFETY AND ENVIRONMENTAL

INTRODUCTION

This chapter covers safety information pertaining to the spin processor system. The spin processor uses high voltage electrical power, mechanical motion, and varying temperatures in the processing of semiconductors. Safety precautions **MUST** be followed when servicing or maintaining the spin processor system.

Service and maintenance personnel should be trained in:

- Electrical safety
- Hazardous Chemical Handling
- Mechanical Motion

NOTE: **Only LTC factory-trained personnel should service the spin processor system.**

Some maintenance tasks may require more than one person to perform. The presence of potentially hazardous chemicals may require two or more workers to safely complete the tasks. Whenever possible turn off and lockout gases, chemical delivery valves, and electrical power before service or maintenance is performed.

Possible hazards associated with the spin processor system are:

- Electrical shock
- Inhalation, exposure, and skin contact with solvent chemicals
- Fire
- Mechanical hazards

Safety procedures associated with the spin processor are noted within this section and throughout this volume. The OEM components for your system also contain specific safety instructions, which are provided in their respective documentation.

Each spin processor is configured to use specific chemical materials in its standard process, as well as facility gases and fluids for certain maintenance tasks. These chemical materials may be hazardous, flammable and/or toxic and require careful handling. Safe handling procedures for these chemical materials are discussed in this manual.

Laurell Technologies Corporation is not liable for damages resulting from improper installation or misuse of their spin processor system. Every operator and service person must read and thoroughly understand the operation and maintenance manuals, as well as any additional information, provided by Laurell with respect to this product.

1.1 LAURELL TECHNOLOGIES ENVIRONMENTAL, HEALTH AND SAFETY POLICY

Laurell Technologies maintains an EHS (Environmental, Health and Safety) policy and will periodically notify its customers of new issues, which may affect the way in which its equipment is being used. All technical information regarding each customer and process use is entered into the company wide database. Hard copy and electronic backups are maintained as part of the company's vital information and recovery policy. This information is reviewed and updated if necessary on a daily basis.

1.2 HAZARD WARNINGS

Potential safety hazards associated with the spin processor system are clearly labeled on the equipment and in this manual using the preferred hazard-warning trilogy of alert words, pictograms, and avoidance techniques. This hazard-warning system is in accordance with ANSI Standard Z535 and OSHA 29 CFR 1910.144-147. The labels will be contained within a box border and will apply to the text immediately following the warning. (See Figure # 1-2A)

Hazard Alert Labels are subdivided into three areas:

- The Level of Hazard Intensity
- Hazard Pictograms
- Hazard Avoidance Text

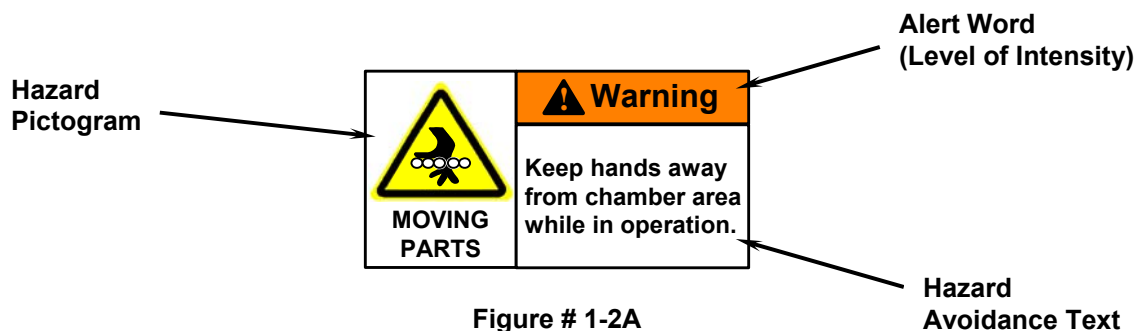

Figure # 1-2A
HAZARD ALERT LABEL

The spin processor manual uses this system of hazard warnings before each service or maintenance procedure that may involve hazards to personnel. When working on OEM sub-systems please refer to the manufacturer's documentation for specific hazard warnings. READ and UNDERSTAND precautions and hazard warnings BEFORE performing any service or maintenance task.

1.2.1 LEVEL OF HAZARD INTENSITY

Alert words are used to communicate the level of hazard intensity. The hazard alerts provided in the manual utilize some or all of the following key words:

“CAUTION”- (Depicted by black lettering on a yellow background) - This indicates potential hazard or unsafe practices or operations that could cause damage to the tool or product. Proper precautions should be taken. (See Figure # 1-2B)



Figure # 1-2B
CAUTION ALERT

“WARNING” - (Depicted by black lettering on an orange background) - This indicates that an immediate hazard exists and special precautions are necessary. Loss of life or limb may occur if WARNING labels are not heeded. (See Figure # 1-2C)



Figure # 1-2C
WARNING ALERT

“DANGER” - (Depicted by black lettering on a red background) - This indicates that an immediate hazard exists, which, if not avoided, will result in serious injury or death. (Typically not used on Laurell spin processor) (See Figure # 1-2D)



Figure # 1-2D
DANGER ALERT

NOTE: All Danger, Warning, and Cautionary notices must be carefully read, thoroughly understood and strictly observed. The users of this product assume the responsibility of implementing all Governmental, Federal, State, and Local safety regulations applicable to the use of this product.

1.2.2 HAZARD PICTOGRAMS

Hazard Pictograms (pictorial hazard alert symbols/icons) are used to visually convey the nature, avoidance technique, and possible consequences of a given hazard, if the instructions are not followed. Pictograms help assure that non-English speaking persons are alerted to potential hazards and how the hazard may be avoided.

Laurell Technologies Corporation has adopted a series of pictograms used to identify various hazards, which may be present in the spin processor. These icons appear in the manual and on the equipment wherever exposure to hazards is possible. Several may be used in each manual; however, not all pictograms are applicable to each system. Figure # 1-2E depicts some or all of the pictograms used on Laurell spin processors. Service and maintenance personnel should become familiar with all of the pictograms shown so that the hazard represented by each will be recognized on sight.

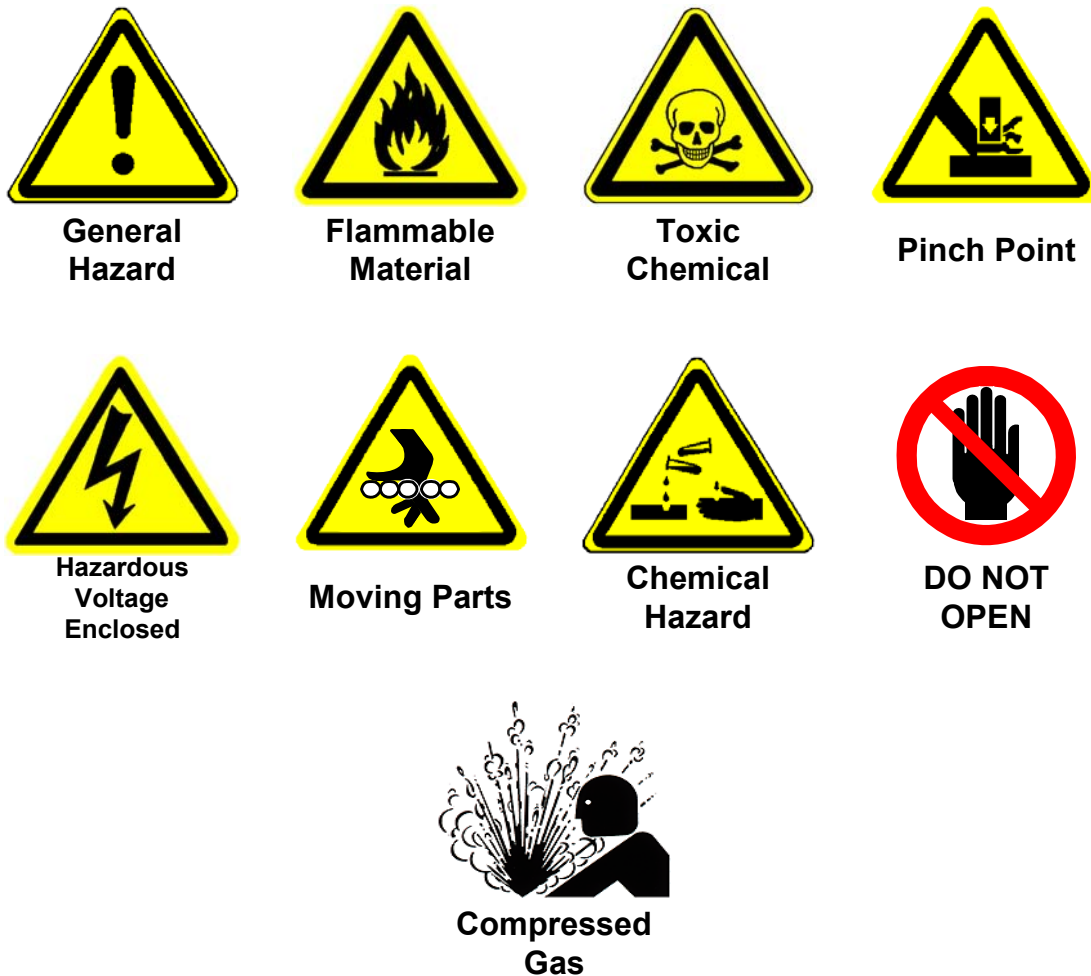

Figure # 1-2E
HAZARD PICTOGRAMS

1.2.3 HAZARD AVOIDANCE TEXT

Text is also used to convey methods of avoiding certain hazards and the consequences that will occur if proper precautions are not taken. (See Figure # 1-2F)



**Figure # 1-2F
AVOIDANCE TEXT**

1.3 EMERGENCY SHUTDOWN OPTION (station installations only)

This spin processor is **NOT** equipped with its own EMO (Emergency Machine Off) circuit; it should be powered by a system with EMO capability. If your safety department or policies allow: simply having the incoming power plug far enough away from the spin processor, properly labeled and fully accessible may be sufficient.

The EMO button area should be located within easy reach of the spin processor operator. In the event of an emergency, pressing the EMO button will remove all power to the spin processor.

After the EMO circuit has been reset and power has been restored, the spin processor will automatically reset. The spin processor will revert to the normal "power up" condition. The motor will revert to a "stopped" condition, and any process that was being performed when the EMO occurred will have been terminated. Any wafer that was being processed during this shutdown may have incurred some damage and should be treated as such.

By following the normal steps, described in Section 3.6, for initiating the spin processor, a new process may be started.

1.3.1 EMO (Emergency Machine Off) PROCEDURE

1. Locate the nearest EMO button.
2. Press the EMO button to immediately interrupt system power.



Figure # 1-3
EMO (Emergency Machine Off) PROCEDURE

1.4 PROTECTIVE APPAREL

Always wear personal protective equipment when handling any potentially hazardous chemicals. Use and maintenance of the spin processor may require using protective gloves, an apron, and chemical goggles and/or face shield, depending on the operation. Be sure to select protective apparel that is appropriate for the chemicals being used. Refer to your company's safety policies and procedures for the personal protective equipment required.

1.5 POTENTIAL EXPOSURE HAZARDS

The following section will cover potential exposure hazards, which may occur while operating the spin processor system.

NOTE: This section should be READ and UNDERSTOOD before using the spin processor.

1.5.1 ELECTRICAL HAZARDS

WARNING



240/115 Volts AC is used throughout the system. Do not attempt to troubleshoot or make repairs. (Refer to Section 2 for spin processor power requirements and main circuit breaker information.)

Electrical components are located internally, and electrical power is distributed throughout the spin processor system. Access can only be gained by removal of the bottom panel, which is secured by screws. Only LTC factory trained, qualified technicians should be permitted to work on an uncovered machine. Use all precautions and safety measures characteristically taken with AC and DC circuitry.

The spin processor should be locked and tagged out according to the procedure outlined below before any maintenance or service is performed.

Maintenance tasks are categorized by "TYPE TASK" as described below. The spin processor has no tasks that are above Type 2. The maintenance manual identifies tasks that may have electrical energy present using the following conventions:

- Type 1 - Equipment is fully de-energized (electrically "cold"). Lockout and tag-out procedures should be used.
- Type 2 - Equipment is energized. Live circuits are covered or insulated. Work is performed at a remote location to preclude accidental shock.
- Type 3 - Equipment is energized. Live circuits are exposed and accidental contact is possible. Potential exposures are less than 30 volts, 42.2 volts peak, 240 volt-amps, and 20 Joules.
- Type 4 - Equipment is energized. Live circuits are exposed and accidental contact is possible. Voltage potentials are greater than 30 volts RMS, 42.2 volts peak, 240 volt-amps, and 20 Joules, or radio frequency (RF) is present

ELECTRICAL HAZARDS CONTINUED

Type 5 - Equipment is energized and measurements and adjustment require physical entry into the equipment, or equipment configuration will not allow the use of clamp-on probes.

NOTE: Unless otherwise noted, all maintenance should be performed with the spin processor system power OFF. There are NO maintenance tasks that require servicing of the spin processor while it is energized.

1.5.2 STATIC ELECTRICITY: BONDING AND GROUNDING



Friction caused by liquids moving can cause a static electricity buildup. If this charge is not properly dissipated, then fires or explosions may occur. Be sure to follow appropriate bonding and grounding practices when supplying flammable and combustible liquids to the spin processor.

1.5.2.1 BONDING

Bonding is creating a metal-to-metal connection between the dispensing and receiving containers to keep them both at the same electrical potential.

1.5.2.2 GROUNDING

Grounding is creating a metal-to-metal connection between the dispensing container and a known grounded object to allow static electricity to dissipate into the ground.

For more information on Bonding and Grounding see NFPA 77, Static Electricity.

1.5.3 MOVING PARTS HAZARDS

WARNING



Use care when opening or closing lids. Lids are heavy, and if dropped accidentally may crush or injure fingers.

WARNING



The chuck on the spin motor can spin in excess of 10,000 rpm. Keep hands and other body parts away from process chamber area. (Refer to Section 3.7 for information on changing chucks.)

1.5.4 AUDIO NOISE HAZARDS



Audible sound pressure readings were taken 3 feet (0.9 m) from the system during normal operation. The background decibel level during standby was measured to be 48 dB(A). The sound pressure readings during normal operations were measured to be 51 dB(A). Readings of less than 80 dB(A) are considered non-hazardous.

1.5.5 CHEMICAL HAZARDS AND COMPATIBILITY

The following section outlines some general guidelines for using chemicals. Refer to Section 2 for more chemical information.

CAUTION



Each spin processor is configured to use specific chemicals for its standard process and includes facility gases and fluids, and maintenance chemicals.

WARNING



The use of incompatible materials in the spin processor is not allowed. If incompatible materials mix in the process chamber or in the waste streams, a hazardous and/or toxic chemical reaction may occur. It is vitally important not to mix or use incompatible materials (i.e., acids with bases, corrosives with organics, acids with organics, etc.). **Before any new chemical is used in the spin processor, the compatibility of the material with other chemicals in the system and the structural materials used in making the spin processor should be investigated.** (Refer to Section 1.6.2 for more information on incompatible chemicals.)

CHEMICAL HAZARDS AND COMPATIBILITY CONTINUED

WARNING



Residual chemicals may be left in the process chamber after processing has occurred. These potentially toxic or corrosive residues may pose inhalation or dermal hazards. Be sure to adequately rinse the process chamber before opening, wear appropriate personal protective equipment and ensure that the spin processor is located in a properly ventilated area that is also protected from splash hazards. (Refer to Section 2.1 for facility requirements.)

1.5.6 SOLVENTS

The following section outlines some general guidelines for using solvents.

WARNING



Most solvents are extremely flammable. Keep all flammable liquids away from ignition sources such as open flames or arcing electrical equipment. Keep all chemicals in a well-ventilated area, preferably in a cabinet designed for such storage.

WARNING



Flammable liquids should be stored and transported in approved safety cans only. When transferring flammable liquids from one container to another, be sure the pouring and receiving containers are bonded to each other and to a ground to prevent static electrical sparks. (Refer to Section 2.1.9 for secondary containment)

WARNING



Never store more than a one-day supply of flammable liquid in the using area, unless it is stored in a cabinet approved for flammable liquid storage.

WARNING



Depending on your location of use, other local fire or building code (e.g. UFC, UBC, NFPA, etc.) requirements may apply in the proper storage, dispensing, and use of flammable materials. Please consult with your local jurisdiction having authority for specific requirements. (Refer to Section 1.6.4 for local restrictions.)

WARNING



Before using solvents, read and understand the safety instructions, provided by the supplier, on the container labels and MSDS (Material Safety Data Sheets). (Refer to Section 1.6.1 for more information on Material Safety Data Sheets.)

1.5.7 ISOPROPYL ALCOHOL - Example

WARNING



Isopropyl alcohol is a colorless liquid with an odor resembling alcohol. It causes irritation of the eyes, skin, and respiratory tract. It is extremely flammable and should be stored separately. Wear eye protection (safety glasses or a full-face shield), gloves, and an apron as recommended by your company's safety department or the manufacturer. If isopropyl alcohol gets on your skin, rinse with water for 15 minutes, refer to the manufacturers MSDS for first aid instructions and contact your company's safety department. Use isopropyl alcohol under a fume hood or in a well-ventilated area.

Inhalation: Inhalation of vapors irritates the respiratory tract. Exposure to high concentrations has a narcotic effect, producing symptoms of dizziness, drowsiness, headache, staggering, unconsciousness, and possibly death.

Ingestion: Can cause drowsiness, unconsciousness, and death. Gastrointestinal pain, cramps, nausea, vomiting, and diarrhea may also result. The single lethal dose for a human adult = about 250 ml (8 ounces).

Skin Contact: May cause irritation with redness and pain. May be absorbed through the skin with possible systemic effects.

Eye Contact: Vapors cause eye irritation. Splashes cause severe irritation, possible corneal burns, and eye damage.

Chronic Exposure: Chronic exposure may cause skin irritation.

Aggravation of Pre-existing Conditions: Persons with pre-existing skin disorders or impaired liver, kidney, or pulmonary function may be more susceptible to the effects of this agent.

1.5.8 HYDROGEN PEROXIDE - Example

DANGER



Hydrogen Peroxide is a strong oxidizer; contact with other material may cause fire and/or corrosive reaction. It may cause burns to skin, eyes, and respiratory tract. Harmful if swallowed.

DANGER



Before using, read and understand the safety instructions provided by the supplier on the container labels and Material Safety Data Sheets.

Inhalation: Vapors are corrosive and irritating to respiratory tract. In severe cases, exposures may result in pulmonary edema and death.

Ingestion: Corrosive and irritating to the mouth, throat, and abdomen. Large doses may cause symptoms of abdominal pain, vomiting, and diarrhea as well as blistering or tissue destruction.

Skin Contact: Corrosive. Symptoms of redness, pain and severe burn can occur.

Eye Contact: Vapors are very corrosive and irritating to the eyes. Symptoms include pain, redness and blurred vision. Splashes can cause permanent tissue destruction.

Chronic Exposure: No information found.

Aggravation of Pre-existing Conditions: Persons with pre-existing skin disorders or eye problems or impaired respiratory function may be more susceptible to effects of the substance.

1.5.9 SULFURIC ACID - Example

DANGER



Sulfuric Acid is a poisonous and corrosive liquid. It will cause severe burns to all body tissue. It may be fatal if swallowed or contacted with skin. Harmful if inhaled. Affects teeth. Water reactive. Cancer Hazard. Strong inorganic acid mists containing sulfuric acid can cause cancer.

DANGER



Before using, read and understand the safety instructions provided by the supplier on the container labels and Material Safety Data Sheets.

Inhalation: Produces damaging effects on the mucous membranes and upper respiratory tract. Symptoms may include irritation of the nose and throat and labored breathing. May cause lung edema, a medical emergency.

Ingestion: Corrosive. Swallowing can cause severe burns of the mouth, throat, and stomach, leading to death. Can cause sore throat, vomiting, and diarrhea. Circulatory collapse with clammy skin, weak and rapid pulse, shallow respiration, and scanty urine may follow ingestion or skin contact. Circulatory shock is often the immediate cause of death.

Skin Contact: Symptoms of redness, pain, and severe burn can occur.

Eye Contact: Contact can cause blurred vision, redness, pain, and severe tissue burns. Can cause blindness.

Chronic Exposure: Long-term exposure to mist or vapors may cause damage to teeth. Chronic exposure to mists containing sulfuric acid is a cancer hazard.

Aggravation of Pre-existing Conditions: Persons with pre-existing skin disorders or eye problems or impaired respiratory function may be more susceptible to the effects of the substance.

1.5.10 HAZARDOUS WASTE

CAUTION



Normal operation and maintenance of the system creates hazardous wastes that require special handling and disposal. Disposal of these wastes must follow all codes, laws, and your company's **safety and health** requirements.



1.5.11 CHEMICAL DISPOSAL

WARNING



Never mix empty acid, flammable liquid, or oxidizer containers in the same waste cans. Chemicals must be handled in accordance with local, state and federal regulations and within the guidelines established by your company. **NEVER** dispose of chemically contaminated wipes or clothes in regular trash. Contact your companies Safety or Environmental Department for instructions on how to handle and dispose of chemically contaminated trash.



1.5.12 ADDITIONAL SAFETY PRECAUTIONS

Full compliance with the following safety practices and those appearing earlier in this chapter is expected.

1. Never work alone on live electrical circuits. You must be within sight or calling distance of another employee who has the following qualifications:
 - Knows how to remove power from the equipment.
 - Knows how to apply artificial respiration.
 - Is acquainted with emergency procedures, first aid locations, and the location and use of fire extinguishers.
2. Turn off, lockout, and tag all hazardous energy sources (e.g., gas, pneumatic, mechanical, gravitational, and electrical) before performing any maintenance.
3. Do not wear rings, wristwatches, or other jewelry on your hands or arms while working on live electrical circuits.
4. Wear eye protection while working on live electrical circuitry where a flash might occur. Do not wear contact lenses.
5. Replace all safety shields after completing setup, troubleshooting, and maintenance procedures.

6. Immediately report any unsafe conditions to your supervisor.
7. Comply with all applicable regulations governing the disposal of hazardous materials. Dispose of waste materials in a manner that will prevent air or water pollution and will not expose humans, animals, or vegetation to hazards.
8. Do not permit smoking or food in the work area.
9. Secure electrical cords and cables where they cannot be tripped over or otherwise accidentally pulled from their connectors.
10. Be sure that all personnel know the location of the main circuit breaker in case of an electrical emergency.
11. Locate fire extinguishers near the equipment. The extinguishers must be approved for electrical or chemical fires in accordance with OSHA and local, state, and federal codes.
12. Operating personnel must NOT remove covers or panels. Only qualified maintenance personnel may make component replacements and internal adjustments only.
13. Do not replace components with the power cable connected. Under certain conditions dangerous voltages may exist, even when the power cable is removed. To avoid injuries, always disconnect power; lock out the circuit breaker and discharge circuits before performing a task.
14. Do not attempt internal service or adjustment unless a person capable of rendering first aid is present. Be sure to follow your company's safety procedures.
15. Because of the danger of introducing additional hazards, do not install substitute parts or make any unauthorized modification to the system.
16. Contact Laurell Field Service for service and repair to ensure that safety features are maintained.
17. Maintain adequate safety precautions when handling toxic chemicals. Avoid breathing dust or spray mist. Use chemicals only with adequate ventilation and keep containers closed when they are not in use. Store chemicals in a locked cabinet where they cannot be removed accidentally.

1.6 ENVIRONMENTAL

1.6.1 MATERIALS SAFETY DATA SHEETS

Before introducing any new chemical, consult the factory specifications. The chemical manufacturer or supplier provides MSDS (Material Safety Data Sheets) for each chemical. The MSDS gives vital chemical safety information on the hazardous components, the chemical's physical properties, spill and leak procedures, waste disposal information, and personal protective equipment required to handle the chemicals involved. Follow the information on the MSDS when handling, refilling chemical containers or cleaning up spilled or leaked materials. Before using solvents, read and understand the safety instructions provided by the supplier on the container labels and MSDS.

NOTE: Laurell Technologies Corporation recommends that copies of the MSDS be kept with this manual and be made available to your employees. There are several websites dedicated to providing chemical information. For reference, Laurell has listed the following:

- <http://www.laurell.com/otherinfo/chemres.asp>
- www.hazard.com/msds/
- <http://webbook.nist.gov/chemistry>

1.6.2 MIXING INCOMPATIBLE CHEMICALS

It is important not to mix incompatible materials in the process chamber and/or waste stream of the spin processor (i.e., mixing acids with bases, corrosives with organics, and acids with organics...). Mixing incompatible materials can result in unwanted chemical reactions in either the chamber, exhaust or drain line. Only compatible materials are recommended for use within the spin processor system. Before any new chemical is used, compatibility of the material with other chemicals in the system and the materials used to construct the spin processor should be investigated. Some of this information may be obtained from the MSDS or the chemical supplier.

NOTE: Use of incompatible materials in the spin processor is strictly forbidden and should not be done under any circumstances.

1.6.3 RECOMMENDED ABATEMENT TECHNOLOGY

The vapor by-products expected in the effluent of the spin processor system should be handled and disposed of in accordance with any and all safety and legal abatement procedures. The recommended abatement technologies for efficient removal of hazardous process by-products are solvent destruction or solvent recovery. Several methods exist that are capable of removing the process by-products from the effluent stream. Some are reportedly more effective than others in terms of efficiency. The oldest abatement technology is to exhaust this effluent into the house *solvent* system, which is normally present in a wafer manufacturing facility.

The trend of the industry is to abate the process by-products at the *point-of-use* (POU), which localizes containment of the process effluent allowing ease of handling. Various POU technologies, as described below, are available for controlling these process by-products.

- *Thermal-oxidizers* convert the effluent gases into other compounds using either flame combustion or a heated catalytic process. The flame combustion requires fuel (usually hydrogen or natural gas) to maintain the flame.
- POU *dry scrubbers* are chemical-absorbent materials that capture the effluent onto absorbent granules. The benefits of dry scrubbers include cost effectiveness, non-hazardous cartridge disposal, and, if available, recycling or recovery of the solvent as a liquid.

More information on abatement technologies may be obtained from Semiconductor Safety Association (a trade group) at (703) 790-1745 or <http://sessaonline.org/>

1.6.4 LOCAL RESTRICTIONS (example)

The use of IPA (Isopropyl Alcohol) creates an environmental concern. Certain local jurisdictions have limitations on, and/or require permits for, the use of organic cleaning solvents. For example, the San Francisco Bay Area Air Quality Management District (BAAQMD) Regulation 2.1.118 limits the amount of volatile organic wipe cleaning solvents that may be used without obtaining a specific permit to 20 gallons per year per source area. Regular wipe down of the spin processor components could exceed this regulation's exemption limits alone or most likely when combined with similar operations at an end-user's facility.

SECTION 2 - INSTALLATION

2.1 FACILITY REQUIREMENTS

2.1.1 FACILITIES

- The spin processor should be installed on a vibration free surface in a clean, temperature and humidity controlled environment to provide the best conditions for repeatable processing results.
- Seal Purge - N₂/CDA (Clean Dry Air) 60 - 70 psi (4.1 – 4.8 bar). N₂/CDA must be moisture free. If moisture is present install an air dryer type filter. For particulate control it is recommended that a point of use filter, 1 micron, or less, be installed after the regulator and before the processor. The seal purge tubing **MUST NOT BE “T”** to supply another output from the same regulator.
- Vacuum - 25 – 28” (635 – 711 mm) Hg of vacuum with a flow volume of 4.5 SCFM (0.11cm³/m) @ 0” Hg
- Exhaust see section 2.1.8 below
- Drain – Open to atmosphere – NOT restricted by a vapor trap (see Figure 2-2C)

2.1.2 SPIN PROCESSOR POWER REQUIREMENTS

- Power - 115 VAC 60 HZ, <3 Amps (7 foot (~200cm) cord with 3 pronged plug)
- Power - 220 – 240 VAC 50/60 HZ, <3 Amps (7 foot (~200cm) cord with correct specified plug)

2.1.3 MAIN CIRCUIT BREAKER

- The circuit breaker on the spin processor is rated for 200A-interrupt current capacity. SEMI S2 requires a minimum of 10,000 AIC for the main disconnect. The end-user of the spin processor system should install a suitably rated circuit breaker (minimum 10,000 AIC) for the circuit if they wish to meet SEMI S2 requirements

2.1.4 DIMENSIONS

- See Appendix for Basic System Dimensions and Installation Diagrams.
- Additional space will be required for pressure vessels and pneumatic fluid/N₂ control valves.

2.1.5 AMBIENT TEMPERATURE

- The Spin processor is designed to run in an ambient temperature of between 68 - 75° F (20 -24° C).

2.1.6 SPIN PROCESSOR CHAMBER PRESSURE

- When optional exhaust is supplied to the chamber it should be maintained at an operational negative pressure of ≥ 0.5 inches (5.08mm) of H₂O. Actual exhaust flow which provides optimal processing results is user defined. The exhaust flow can be controlled by our optional down flow exhaust adapter.

2.1.7 DISPENSE LIQUIDS

- Manual syringe (optional)

2.1.8 EXHAUST REQUIREMENTS

- The spin processor is intended for use in an exhausted bench area. The end user is responsible for providing exhaust for the bench area.

	Volumetric Flow rate (CFM)*	Static Pressure (in H ₂ O)*	Duct Material	Type of Exhaust
Solvent Storage Cabinet	Solvent Storage Cabinet not supplied by Laurell			
Chamber Drain Port	25 (.71M ³)	.5 to 2.5"	PP	Chemical / Solvent

Note: These measurements were taken in the exhaust duct 3 inches from the system after the first elbow.

2.1.9 VACUUM PUMP (OPTION)

- LTC provided vacuum pump:
 - 25 – 28" (635 – 711mm) Hg with a flow volume of 4.5 scfm (0.11cm/m) @ 0"Hg
 - Power - 100 – 115 or 220 – 230 VAC - 50 / 60 Hz.
 - It is recommended to install the pump in an open and well ventilated area. Normal operating temperature after 1 hour of use is $75 \pm 5^{\circ}\text{C}$ ($165 \pm 9^{\circ}\text{F}$). Pump is design for continuous use. The factory thermal protection interlock is sensed on the motor windings and set for $135 \pm 5^{\circ}\text{C}$ ($275 \pm 9^{\circ}\text{F}$). The thermal reset temperature is $61 \pm 9^{\circ}\text{C}$ ($142 \pm 16^{\circ}\text{F}$). **Caution:** Pump will be hot after continuous use. Allow time for cooling before handling pump.

2.1.10 SECONDARY CONTAINMENT AND SPILL PREVENTION FEATURES

- When installed at the end-user site, secondary containment is recommended. It should provide for the spin processor and the pressurized tank(s). All secondary containment should incorporate appropriate gas detection, liquid sensors, and alarms. If incompatible materials are used in the spin processor, (not recommended by Laurell) containment should be designed to ensure that the

materials could not be combined. Automatic shutoff capability should be considered for bulk distribution systems. The secondary containment provided should be able to contain 110% of the volume of the largest single container or all vessels combined.

2.2 INSTALLATION

SEE FRONT OF MANUAL FOR “QUICK START INSTALLATION INSTRUCTIONS”.

The first step in the installation is to unpack the spin processor. Identify each component on the packing list and verify that it was not damaged during shipping. Any loss or damage must be reported to the factory within 30 days from shipment.

Refer to section 2.1 “Facility Requirements” for required electrical power, vacuum, drain, exhaust, and N₂/CDA (Clean Dry Air). Since each spin processor is configured to meet the needs of the end-user, requirements will vary for each application. It is recommended that a point-of-use filter (≤ 1 micron), a pressure regulator and a check valve (5 PSI breaking pressure) be installed on all supply tubing connected to the spin processor. Refer to installation drawing(s) in Section 5 for guidance.

2.2.1 SPIN PROCESSOR CONNECTIONS

- Follow the outline in section 2 “Facilities” to prepare for installation. Use dedicated regulators and filters where appropriate.
- **See “Quick Start Instructions” in front of manual for step-by-step installation instructions.**
- Install the processor on a stable, level and vibration free surface.
- Connect drain line to rear of spin processor’s drain adapter. **See Quick Start Instructions.**
- Connect vacuum source, using the provided 3/8” (9.52mm) O.D. x 1/4” (6.35mm) I.D. tubing, to the 3/8” fitting on the vacuum control valve (right rear side of spin processor). (Applicable only if vacuum-type chuck is used.) **Note: vacuum supply tubing should be 1/4” I.D. or larger to provide sufficient volume quickly. See Quick Start Instructions.**
- Connect 1/4” O.D. tubing for Seal Purge to N₂ / CDA regulator. Set regulator to 60 -70 psi. **See Quick Start Instructions.**
- Connect power cord to an appropriate AC source. Note: the circuit breaker, located on the back of the processor, is also a power switch, which when pressed and the button is extended, will turn the system off.

2.2.1.1 COMPRESSION FITTING ASSEMBLY

FITTING ASSEMBLY

This diagram will guide you in the proper assembly of your system fittings. Although your fitting may not match the picture exactly, all fittings follow the same installation arrangement. There is no need to use Teflon tape on any of the fittings. All fittings only need be hand-tightened for a proper seal.

ASSEMBLY INSTRUCTIONS

Please follow these diagrams in assembling nuts.
As shown below, insert gripper (B) into nut (A).
Push sleeve (C) into nut assembly.

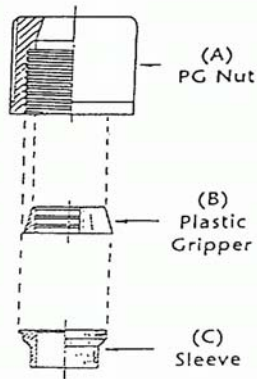

2.2.2 TYPICAL INSTALLATION DRAWING

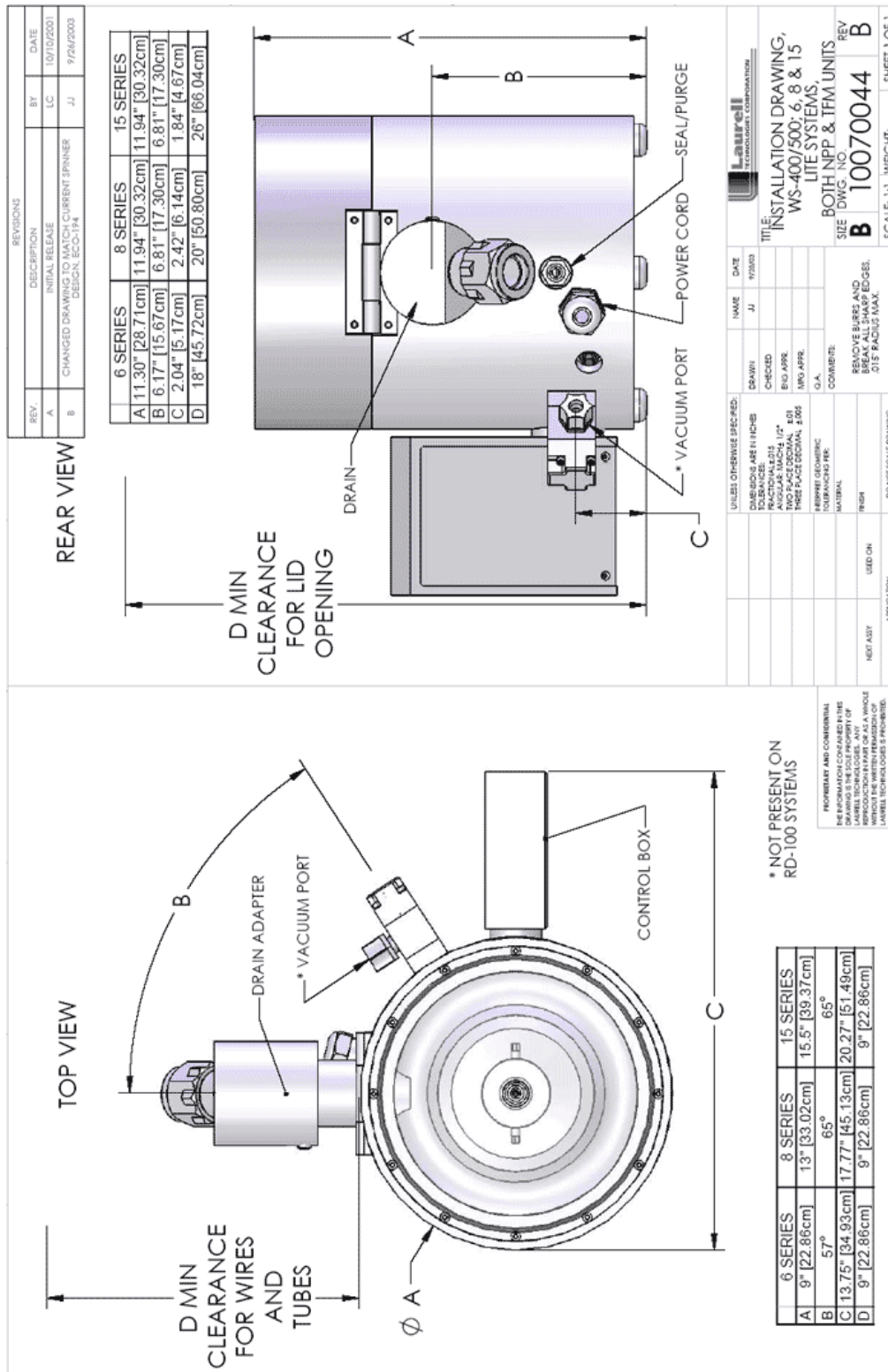

Figure 2-1
 INSTALLATION DRAWING 10070044

2.2.3 DRAIN AND EXHAUST CONNECTIONS

Figure 2-2A is the standard drain configuration. Exhaust is optional on the standard LITE model. Figure 2-2B is our down-flow exhaust option. An exhaust source of approximately 0.5" to 2.5" H₂O column, as measured with a differential pressure gauge, is usually sufficient for processing. Figure 2-2C is a drawing of the recommended drain configuration.

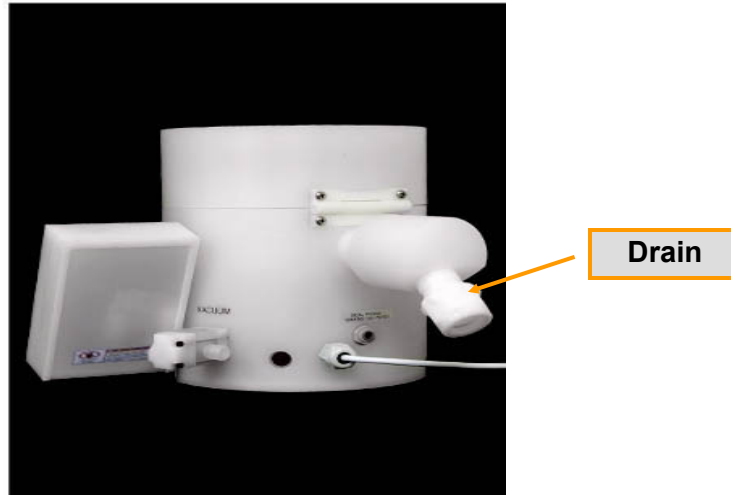

Figure 2-2A

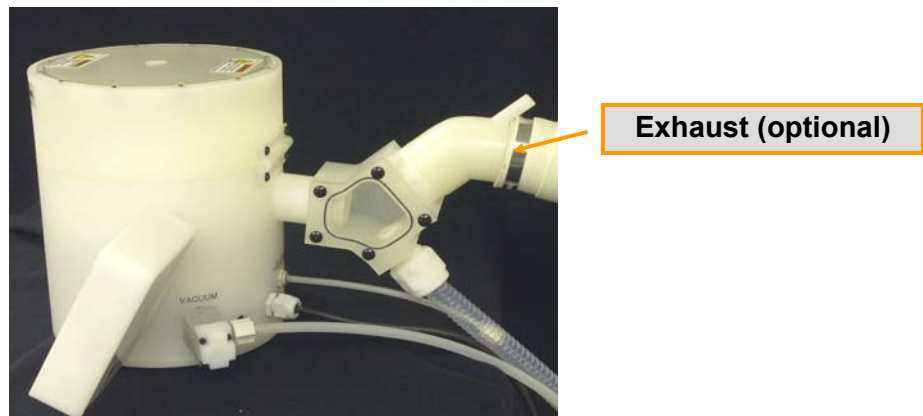

Figure 2-2B

DRAIN AND EXHAUST LOCATIONS

Standard Configuration (Top) / Optional Exhausted Drain Assembly (Bottom)

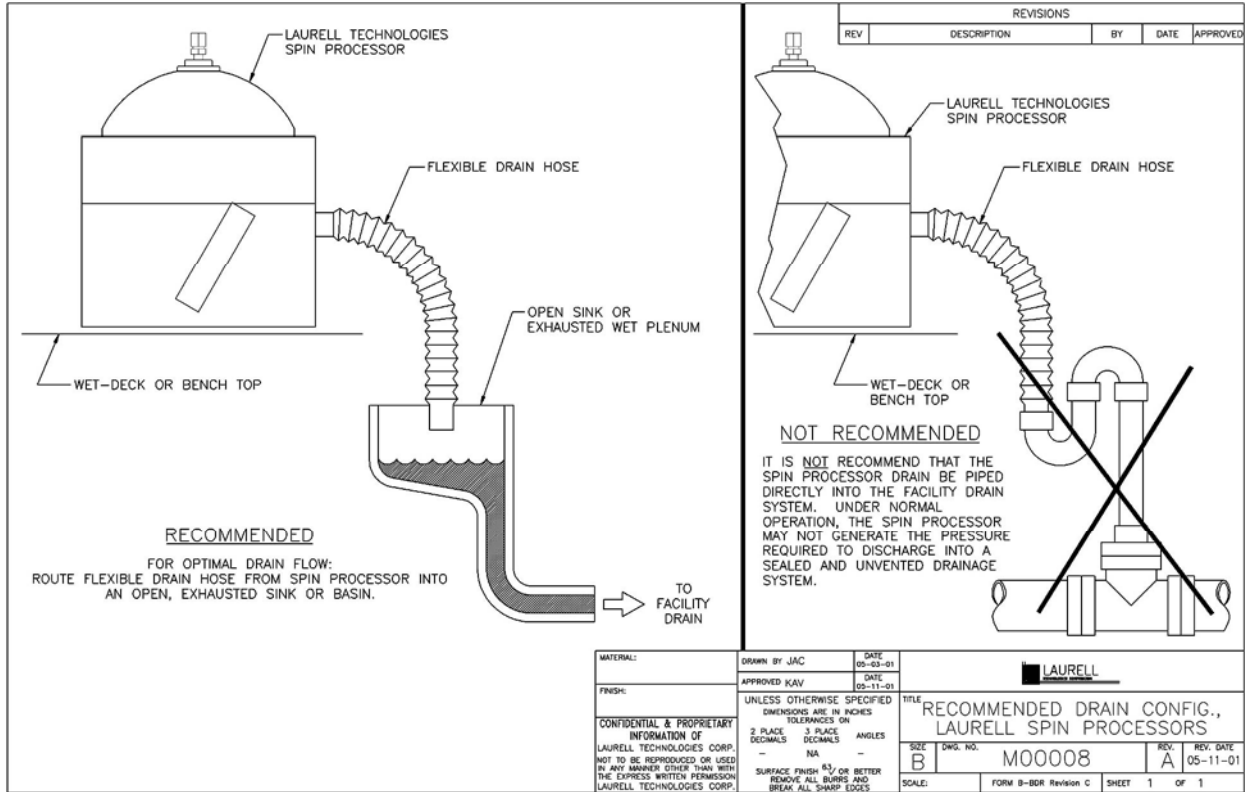

Figure 2-2C
RECOMMENDED DRAIN CONFIGURATION

2.2.4 INDECK CONNECTIONS

Indeck installations require cabling the remote control box assembly to the spin processor. Two cables and one vacuum sensor hose are required, which can be detached at the rear of the remote control box (see photo below, Figure 2-3A, for plumbing and electrical hook-up).

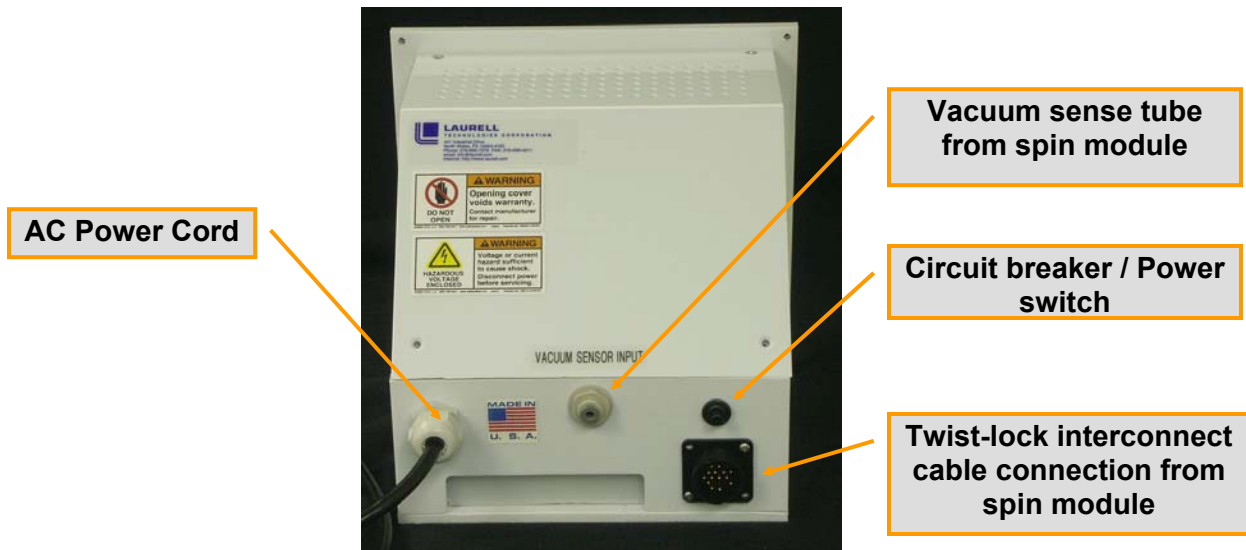

Figure 2-3A
INDECK CONTROLLER – REAR VIEW

The spin processor vacuum connection and drainpipe are located on the bottom of the spin processor housing (see photo below, Figure 2-3B, for plumbing and electrical hook-up).



Figure 2-3B
DRAIN AND EXHAUST LOCATIONS

SECTION 3 - OPERATION PROCEDURES

GENERAL

All operational controls are interfaced through the spin processor's membrane switch keypad and the LCD (Liquid Crystal Display) figure 3-1. The display shows relevant information specific to the programmable controller mode selected. (See Section 3.3 – Keypad for illustrations.)

During normal operation the mode status, step-of-steps, program ID, set point RPM, set point time, time remaining/time running (selectable using the up and down arrow keys), actual wafer RPM, and valve status for each step of a program are displayed. Up to twenty (20) process programs (labeled A through T), containing up to fifty-one (51) steps each, can be permanently stored in non-volatile memory. Each program step includes: time of step, wafer rotation speed in RPM, and acceleration/deceleration set point (acceleration/deceleration rate is shown in program mode only).



**Figure 3-1
INITIAL DISPLAY**

A vacuum interlock assures that vacuum is activated before any program can run and vacuum will not disengaged until the wafer comes to a complete stop. Units are equipped with a vacuum sensor to additionally ensure that sufficient vacuum is provided to hold down the substrate during operation of the spin processor. All spin processors are equipped with a Seal Purge pressure switch to ensure that sufficient purge pressure is provided. The Seal Purge switch will disable the spin processor operation if insufficient pressure is detected. A safety lid interlock disallows motor rotation if an open lid condition is detected. A design feature is included to avoid the accidental re-running of a process on the same wafer indicated by "END" as opposed to "OFF". In order to run a program twice on the same substrate, the lid must be opened or the program must be changed. If you desire to run the same substrate more than once simply press the F1 key twice. This allows the cycling of a program without opening the lid. The unit will automatically go into a sleep mode ~10 minutes of non-use, eliminating power to display backlighting and vacuum valve control however the system is still fully functional. Pressing any key will fully reactivate the unit.

3.1 POWER

All units are equipped with a single pole over current circuit breaker with manual reset. This breaker is located on the body of the spin processor housing near the AC cord entry location (Indeck systems on the remote controller's rear panel). Seeing the white band of the "reset" button is indicative that the power has been interrupted. During normal operation, the circuit breaker should never trip. If the circuit breaker does trip, a visual and mechanical inspection of the unit should be performed before resetting the circuit breaker.

This circuit breaker also serves as an "ON/OFF" switch for the unit. Pressing the "reset" button will toggle power on and off to the unit.

3.2 INTERLOCKS

3.2.1 LID INTERLOCK

A hidden lid interlock switch disables the spin processor's motor operation when the lid is in the open position. If the lid is opened while running a program, the program will be interrupted and the chuck rotation will stop slowly. This condition is noted by a **flashing "LID"** indicator on the second line of the LCD display. The program can be continued from the point at which it stopped by closing the lid and pressing the **RUN/STOP** key. (See Figure 3-2)



Figure 3-2
FLASHING LID DISPLAY

3.2.2 VACUUM INTERLOCK

Two conditions must be met to allow operation of systems equipped with a vacuum hold down type chuck.

The first condition that must be present is a vacuum source with vacuum ≥ 15 "Hg. A factory preset sensor will not allow the system to operate with vacuum < 15 "Hg. This interlock insures that adequate vacuum is applied to the substrate. Inadequate vacuum will cause an unsafe condition and may cause a substrate to spin off the chuck and cause breakage. A **flashing** value (measured in inches of Hg) of the vacuum applied to the substrate is an indication that this requirement has not been met. Without proper vacuum, a process cannot be started. If the vacuum falls below the required level while a process is running, the program will be halted at that point and an E04 error message will appear on the LCD display¹. Once vacuum has been re-established it is necessary to press the **RUN/STOP** key on the keypad to re-start the program from where it stopped.

The second required condition, which MUST be present for the air operated vacuum valve to function, is sufficient seal purge pressure. Since the vacuum valve is pneumatic it must have enough N2 / CDA to operate. See section 3.2.3. If there is insufficient N2/CDA pressure the controller will **flash "CDA"** and **"VACUUM"** indicating no CDA or vacuum. (See Figure 3-3 for an illustration of this condition.) If there is ≤ 60 psi of CDA the vacuum screen may show that there is vacuum ≥ 15 "Hg but the lack of N2 / CDA will **flash "CDA"** and cause an E10 error. **WITHOUT THE PROPER N2/CDA PRESSURE THE SYSTEM WILL NOT OPERATE.**

Press the VACUUM button on the keypad to turn on/off the vacuum valve. Once actuated, the vacuum valve cannot be turned off until the motor is stopped @ 0 RPM for 1 second. This safety feature insures that vacuum cannot be inadvertently turned off until the chuck comes to a complete stop.

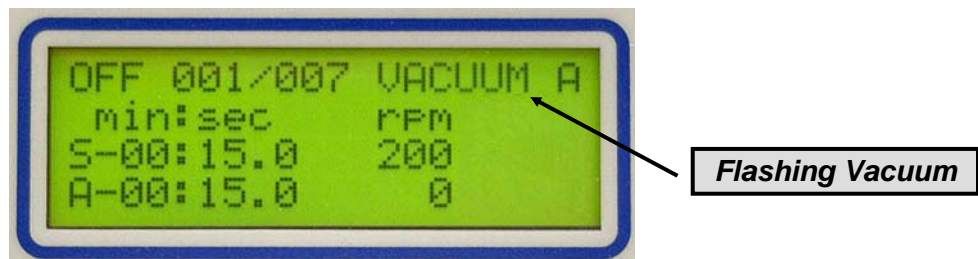

Figure 3-3
FLASHING VACUUM DISPLAY

¹ See Section 4.1 - Errors

3.2.3 SEAL PURGE INTERLOCK

All of our systems require at least 60 PSI (4.1 bar) of Nitrogen/CDA (Clean Dry Air) to pressurize the labyrinth motor seal. **If Nitrogen/CDA (Clean Dry Air) is < 60 PSI (4.1 bar) the processor WILL NOT OPERATE.** The seal's purpose is to separate the process chamber from the motor and electronics in order to insure long service-free operation. The gas consumption is very low (≈ 3 cubic feet per hour). **We recommend a constant CDA supply even when the processor is not in use.** Nitrogen/CDA pressure is monitored by a pressure sensor interlock. This interlock will report an "E10" error if the pressure should drop below the 60 PSI (4.1 bar) requirement during operation. The interlock will not allow a new process to begin until the minimum pressure of 60 PSI (4.1 bar) is met. If the purge falls below the required level while a program is running, the program will be halted at that point, an E10 error message will be displayed, and a **flashing "CDA"** will appear on the LCD display², figure 3-4. Once purge pressure has been re-established, it is necessary to press the **RUN/STOP** key on the keypad to re-start the program.

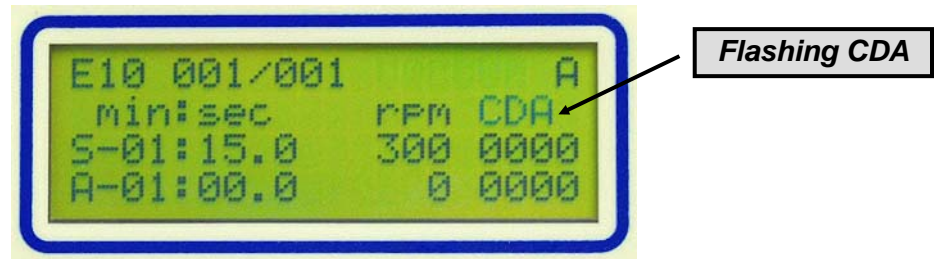

Figure 3-4
FLASHING CDA DISPLAY

3.2.4 POWER ON LID CHECK

When powering on your equipment, the spin processor will initialize in an "END" mode. This condition will persist until **THE LID IS OPENED**. This ensures the proper operation of the lid switch before the spin processor can be operated (see Section 3.6, #5 for more on "END" mode).

² See Section 4 - Errors

SECTION 3.3 - KEYPAD

All operator interface actions are initiated through the membrane switch keypad, figure 3-5. The function of each key is as follows:

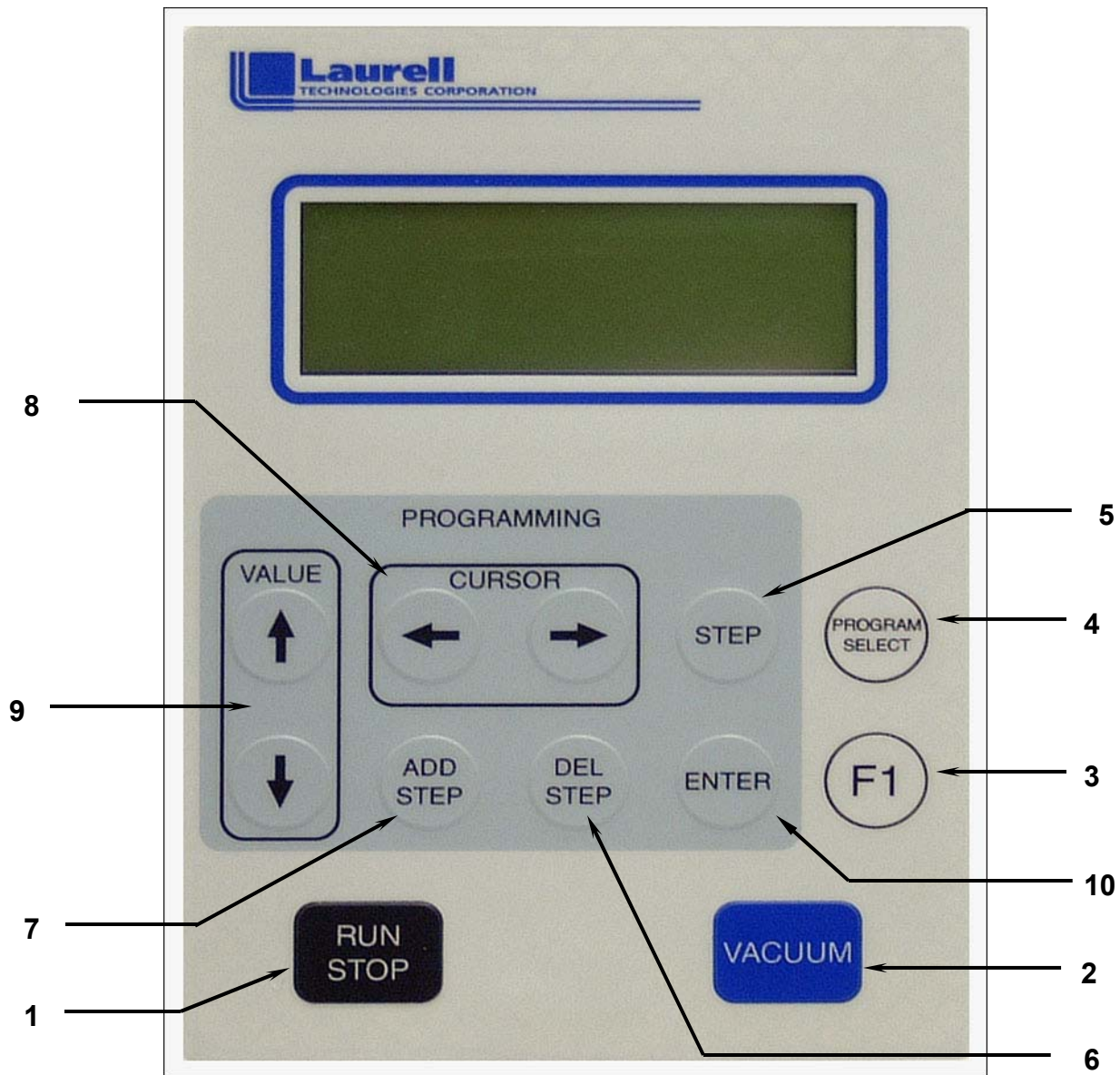

Figure 3-5
KEYPAD



NEVER flood or spray solvent such as acetone or any other type of cleaner directly onto the keypad surface. Doing so may cause keypad failure. Always wet a wipe or cloth with the solvent and gently wipe the keypad surface.

3.3.1 OPERATIONAL KEYS

1. **RUN/STOP** - this key is used to initiate or terminate a programmed sequence. While a program is running the mode display will indicate **RUN**. **END** indicates that a complete program has run one time and will persist until the lid is opened or another program selection is made. This key is disabled until the vacuum, seal purge and lid interlocks are satisfied.
2. **VACUUM** - this key toggles the vacuum valve on and off. A *flashing* **VACUUM** indicates the vacuum valve is de-energized. This key is interlocked such that the vacuum cannot be turned off while a program is running or the chuck is in motion. The value is displayed in inches of Hg when the vacuum valve is turned on. The normal requirement to operate safely is 15" of Hg vacuum. This requirement can be modified in the "setup" mode.
3. **F1** - this special function key is used to toggle between the program "PGM" and "RUN" modes. Pressing the **F1** key will place the spin processor in the "program" mode (**PGM** will now be displayed). A program can be run when in the PGM mode. When running in the PGM mode, step, acceleration, speed and optional valves are operational. The time value is ignored in the PGM mode. The user can manual step through a program while it is running by pressing the "STEP" key.
4. **PROGRAM SELECT** - this key is used to select the desired program to be run or modified and is disabled while a program is running. Pressing this key ascends or descends to the next program selection. The selection is controlled by using the up and down direction keys, \uparrow for A, B, C and \downarrow for C, B, A.
5. **STEP** (Active in PGM mode only) - this key is used to advance a program sequentially through its steps. **STEP** is used during programming to enter and view set values for each step. This key is always active when in the "program" mode. It can be activated for the "run" mode by enabling a special function (call factory for instruction sheet to activate "skip step").
6. **DEL STEP** (Active in PGM mode only) - this key is only activated in the "program" mode and is used to delete a step from the program indicated in the **PROGRAM SELECT** area of the display. When pressed, a flashing *delstep* message will appear in the "actual time" area of the display. If the **ENTER** key is pressed within 5 seconds to acknowledge the command, the last step of the selected program will be deleted from the program. This function is disabled when there is only one step in the program or in the "setup" mode and "LOCK" is set to one (1).
7. **ENTER** (Active in PGM mode only) - When deleting a step, it is used in conjunction with the **DEL STEP** key to acknowledge the command.

8. **ADD STEP (Active in PGM mode only)** - this key is only activated in the “program” mode and is used to add a step to the program indicated in the **PROGRAM SELECT** area of the display. The step area of the display will be updated to the new number of steps in the program. The new step is added to the end of the program. Pressing the **STEP** key will advance to and allow programming of the new step. This key is disabled when the maximum number of steps (currently 51) in a program is reached or in the “setup” mode and “LOCK” is set to one (1).
9. **Cursor ←(Left) & →(Right) (Active in PGM mode only)** - the cursor arrow keys are used to position a blinking cursor over set point data to be changed (i.e. TIME, RPM, and ACCELERATION).
10. **Value ↑(UP) & ↓(DOWN)** - during “program” mode these keys are used to change values highlighted by the blinking cursor. Limits are placed on certain parameters that match the performance of the system. Motor speeds (RPMs) that exceed the capability of the installed motor cannot be programmed. In the “run” mode these keys are used to select the method of counting of the “run time” indicator and direction of **PROGRAM SELECT** key. The **↑** key selects the elapsed time mode while the **↓** key selects the time remaining mode.

SECTION 3.4 - THE LCD DISPLAY

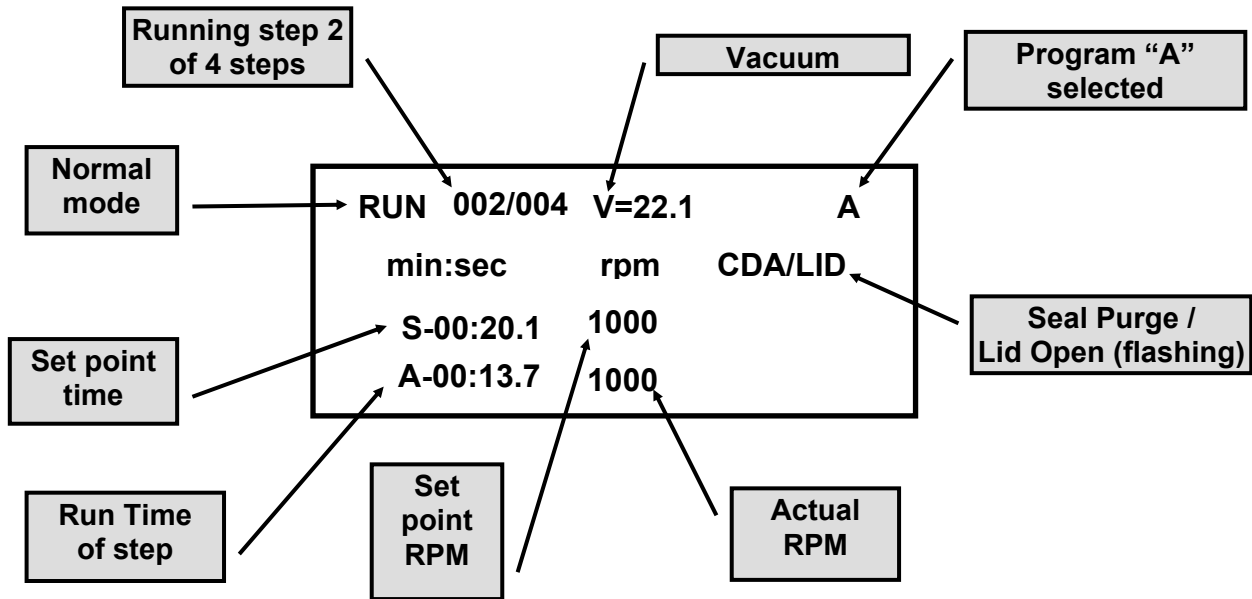

Figure 3-6A
 ACTUAL LCD DISPLAY VIEW

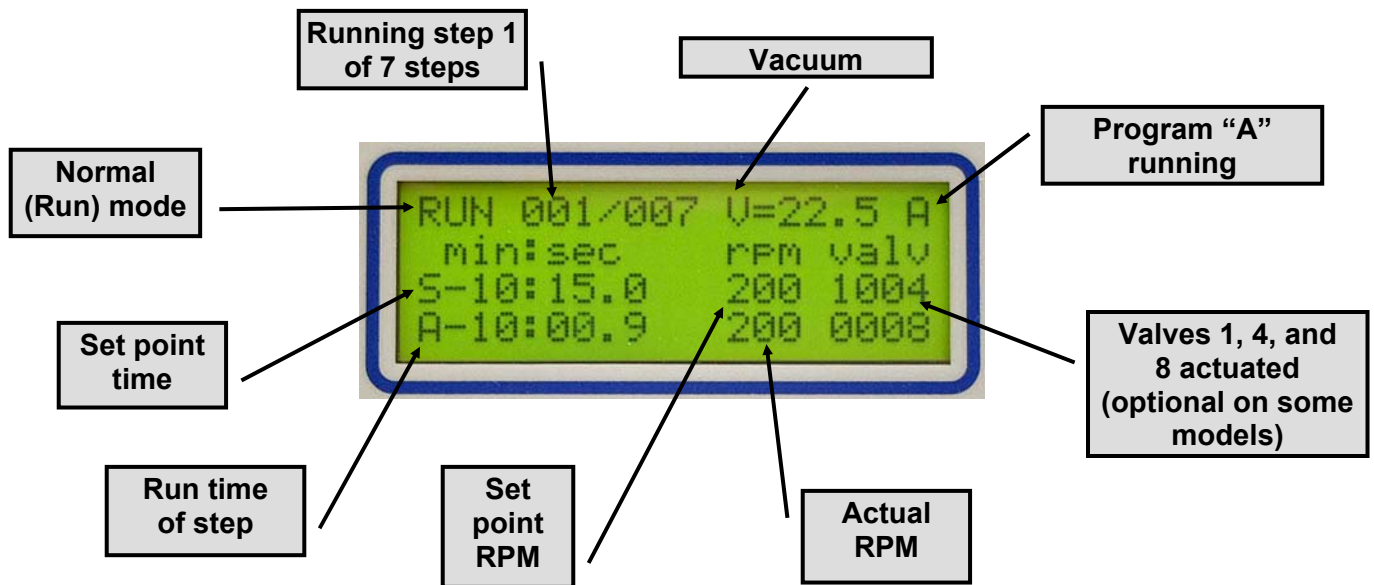

Figure 3-6B
 LCD DISPLAY LAYOUT

3.4.1 LINE ONE OF LCD DISPLAY

The first line of the display indicates the status and mode of the spin processor. (See Figure 3-6A & 3-6B above) The information displayed on this line includes:

- **MODE** - displays either **RUN**, **OFF** or **END**, in the upper left corner, during normal operation. It will display **PGM** during “programming” mode. “Run” mode is entered when the **RUN/STOP** key is pressed and all interlocks are satisfied. Pressing the **F1** key while the indicator displays **OFF** or **END** will allow changing between the “program” and “run” modes. The “program” mode is used to modify or display the information for each step in a program.
- **STEP** - (e.g. 001/003) displays the present step number and the total number of steps in the selected program. Currently up to fifty-one steps can be entered for each of the twenty programs.
- **V** - Indicates the vacuum on the wafer in inches of Hg. “VACUUM” will flash if the vacuum valve is off. The vacuum interlocks must be satisfied for the spin processor to operate. A minimum vacuum setting (factory setting 15.0” Hg) is required. If insufficient vacuum is detected, the value will be flashing. Pressing the **VACUUM** key will toggle the vacuum valve from “off” to “on”.
- **PROGRAM SELECTED** - the present program selected is shown in the upper right corner of the display. The program is indicated with the letters (A – T). See figure 3-7.

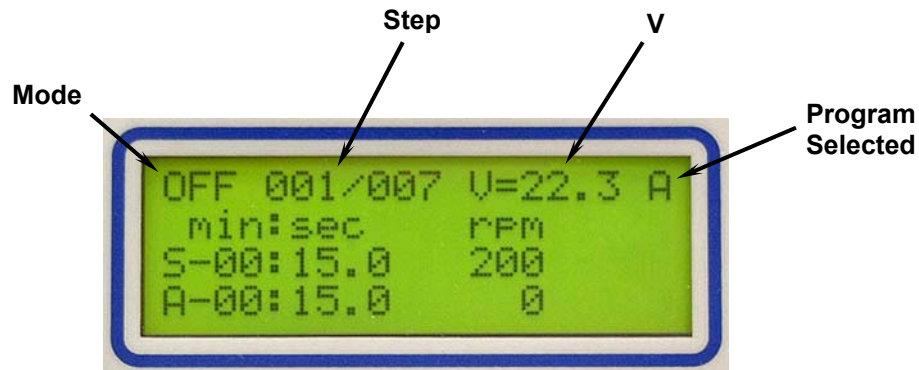

Figure 3-7
VACUUM SETTING

3.4.2 LINE TWO OF LCD DISPLAY

The second line of the display is used as a heading for information displayed on the third and fourth lines. The headings are **min:sec** for the time of each step, and **rpm** for spin speed in revolutions per minute. Additionally, error messages or conditions will be displayed at the end of this line. An error example would be when the spin processor's lid is left open - the message **LID** will *flash* here (See Figure 3-8)

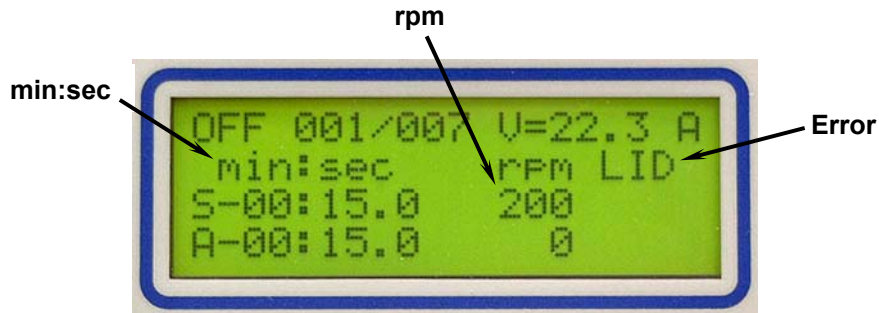

Figure 3-8
FLASHING LID DISPLAY

3.4.3 LINE THREE OF LCD DISPLAY- SET POINT VALUES

The third line of the LCD display indicates the "set" data programmed for TIME and RPM for each step in a program. (See Figure 3-9)

- **S** - used to indicate set point values.
- **min:sec** - displays the set point time in minutes and seconds for each step in a program. The time resolution for each step is 0.1 seconds. The maximum value that can be displayed is 99:59.9.
- **rpm** - display shows the set point RPM for each step in a program.



Figure 3-9
SET POINT VALUES

3.4.4 LINE FOUR OF LCD DISPLAY - ACTUAL VALUES

The fourth line of the LCD display indicates the “actual” data for TIME and RPM for each step in a program. (See Figure 3-10)

- **A** - used to indicate actual values.
- **min:sec** - displays the run time in minutes and seconds for each step in a program. This can be displayed as either time remaining (down counting) or elapsed time (up counting). Pressing \uparrow or \downarrow keys will toggle between the two modes of counting. The time resolution for each step is 0.1 seconds.
- **rpm** - display shows the actual RPM during each step in a program.



Figure 3-10
ACTUAL VALUES

SECTION 3.5 - PROGRAMMING

1. Fill out the enclosed programming sheet(s).
2. Place unit in “programming” mode by pressing the **F1** key. The **PGM** message will appear in the mode area of the display to indicate that the unit is in “programming” mode.
3. Select the program letter, “A” through “T”, to be modified using the **PROGRAM SELECT** key. The program letter selection will be indicated in the upper right area of the display.
4. Use **ADD STEP** & **DEL STEP** keys to select or remove the number of steps necessary in the program. Up to 51 steps can be programmed.
5. Use **Cursor** \leftarrow (L) & \rightarrow (R) keys to position the cursor over the value to be changed.
6. Use **Value** \uparrow (UP) & \downarrow (DOWN) keys to change set point values or enable and disable valves. Repeat steps 5 and 6 until all parameters for a given step agree with programming sheet.

7. Use **STEP** key to advance to the next step.
8. Repeat steps 5, 6, and 7 until all steps have been entered.
9. Use **STEP** key to step through program and verify that all values are correct.
10. Press **F1** key to return to “run” mode.

➤ **Example of a dynamic dispense coat program.** This is for example only; the user must find the best parameters for their process.

PROGRAMMING EXAMPLE

Program: A

Step	Time		Speed 0-6,000	Accel Index	Comment
	99	59.9			
	Min	Sec		0-15	
1		5-7	300 - 1000	015 is recommended	This step is to get the chuck rotating at the dispense step spin speed.
2		3-6	Same as step 1	Same as step 1 - 015	Dispense Step Spin speed same as step 1. Dispense time enough to coat substrate. Dispense amount ~0.5 –1.0 ml / inch
3		2-3	1 – 3k	Same as step 1 - 015	Intermediate spin speed between dispense speed and final speed. Can be the same speed as dispense step. This step is not always used.
4		20-30	2 – 6k	Same as step 1 - 015	Final spin speed to achieve target thickness.
5					

3.5.1 PROGRAMMING ACCELERATION/DECELERATION (standard motor)

An acceleration/deceleration **index value** can be programmed for each step of a process, figure 3-11. The display will show two associated acceleration numbers, only one of which can be modified³. The **acceleration index (ACL)** is the first item on the last display line, which can be changed. The second number is **calculated acceleration** or **deceleration** in RPMs per second, this number is calculated and

³ Line 4 of LCD Display

cannot be changed. For example, if the first step of a program had a set speed of 3000 RPM and a calculated acceleration of 500 RPM per second, it would take 6 seconds to reach 3000 RPM (Chuck and substrate mass may affect results).

PROCESSING TIP: *The default value (015) will work well for most applications. Entering values that exceed the capability of the motor will cause overshoots of the set point speeds. Deceleration values should not exceed 1000 RPM/second, while acceleration values in excess of 32,000 RPM/second are not usually achievable with the standard motor.*



Figure 3-11
PROGRAM MODE

Acceleration
index (settable)

Calculated
acceleration
(readout only)

SECTION 3.6 - NORMAL OPERATION (“OFF/RUN” Mode)

1. Select the program to be run using the **PROGRAM SELECT** key. A letter “A” through “T” (20 programs) will be indicated in the upper right corner of the display.
2. Place a wafer on the chuck and, if equipped with a vacuum hold down chuck press the **VACUUM** key to activate the vacuum valve. Sufficient vacuum to hold the wafer will be required to start the motor. The requirement to activate vacuum hold down should always be eliminated when using only non-vacuum chucks. Contact the factory or read instructions sent with your new non-vacuum chuck to reconfigure the system for non-vacuum use.
3. Close lid.
4. Press **RUN/STOP** key to start a program. The program will not start until the vacuum hold down requirement is met (vacuum chucks only), the seal purge requirement is satisfied, and the lid is closed. The program will stop automatically if the lid is opened, the CDA/N₂ motor seal purge is not satisfied (>60 PSI) or the vacuum requirement for hold down is not maintained. The remaining process time will be maintained.

5. **END** is indicated in the mode display when a process has been completed and the lid has not yet been opened for wafer removal. Restarting the same sequence on the same wafer is not allowed until the lid is opened or a new program is selected. Pressing **F1** twice will override this interlock.

➤ **PROCESSING TIP:** For improved coating uniformity cover the 19mm hole in the lid after the dispense step. If using static dispense cover the hole before processing.

SECTION 3.7 - REMOVING/CHANGING CHUCKS

3.7.1 SCREW ON TYPE CHUCK

- Hold the two horizontal arms on the column below the base of the chuck. Turn the chuck counter-clockwise to remove (see fig. 3-12A), and clockwise to install, making sure the chuck is snug (see fig.3-12B).
- **DO NOT OVER TIGHTEN (especially Teflon)!**

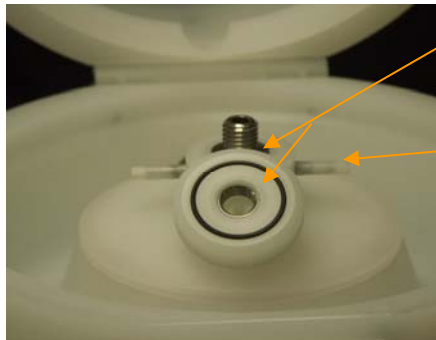

Figure 3-12A

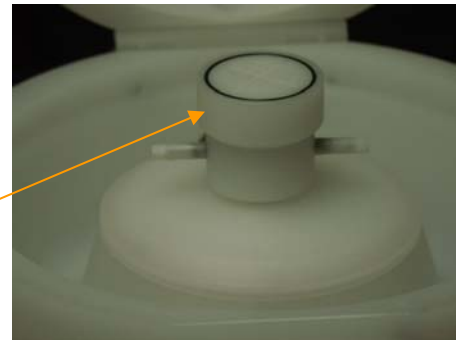
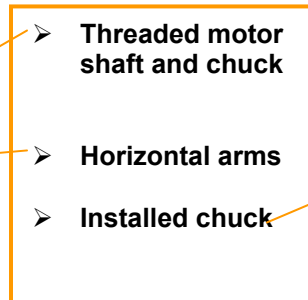
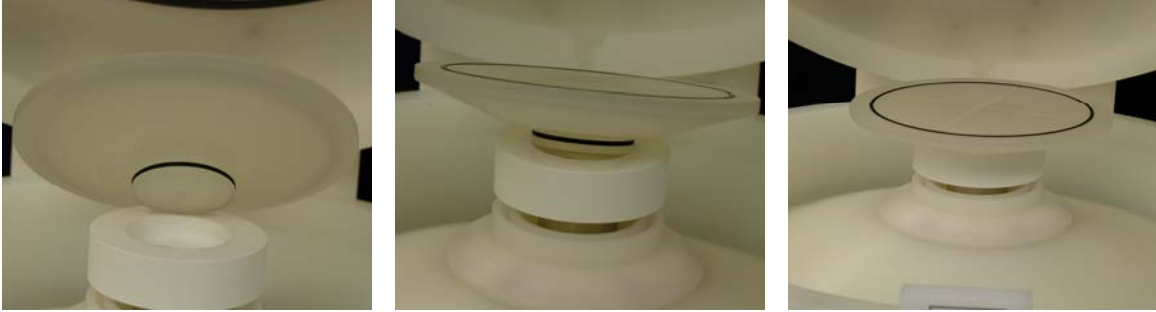

Figure 3-12B

3.7.2 BOLT DOWN TYPE CHUCK

Laurell Technologies uses a bolt down type chuck with all 300 mm models and with all High Performance Drive (HPD2) motors. There are two styles of chucks offered which are interchangeable – the first is a chuck drive base and insert and the second is an entire integrated chuck assembly which also can have a chuck insert or cover plug in the center. See photos below to identify which bolt down chuck design you have.

1. **Chuck Insert:** To remove the chuck insert, gently lift up on the edges; lift one side then the other. To install a chuck insert (see figure 3-13), insert the bottom of the chuck with o-ring in place, into the chuck's drive base. Be sure to firmly push the chuck into place (it should only offer slight resistance).



**Figure 3-13
INSTALLING INSERT CHUCK**

- 2. Bolt Down Chuck Assembly:** The first step to removing the chuck insert is to, by hand, disengage it from the drive base (see figure 3-14). Once the insert is removed, you will notice the 3 screw heads. Use a 9/64 Allen wrench to remove all the screws/bolts and gently pull the chuck upward until it is free of the motor shaft adapter. Replacing the chuck base is done by inserting it onto the motor shaft adapter, replacing and tightening the screws/bolts, and gently pressing the insert back into place. **Do not force the chuck into position, or hit with anything to seat it (STOP immediately and contact the factory for advice).**

NOTE: Laurell Technologies Corporation does not warranty any damage to the equipment caused by incorrectly installing a chuck or substrate.

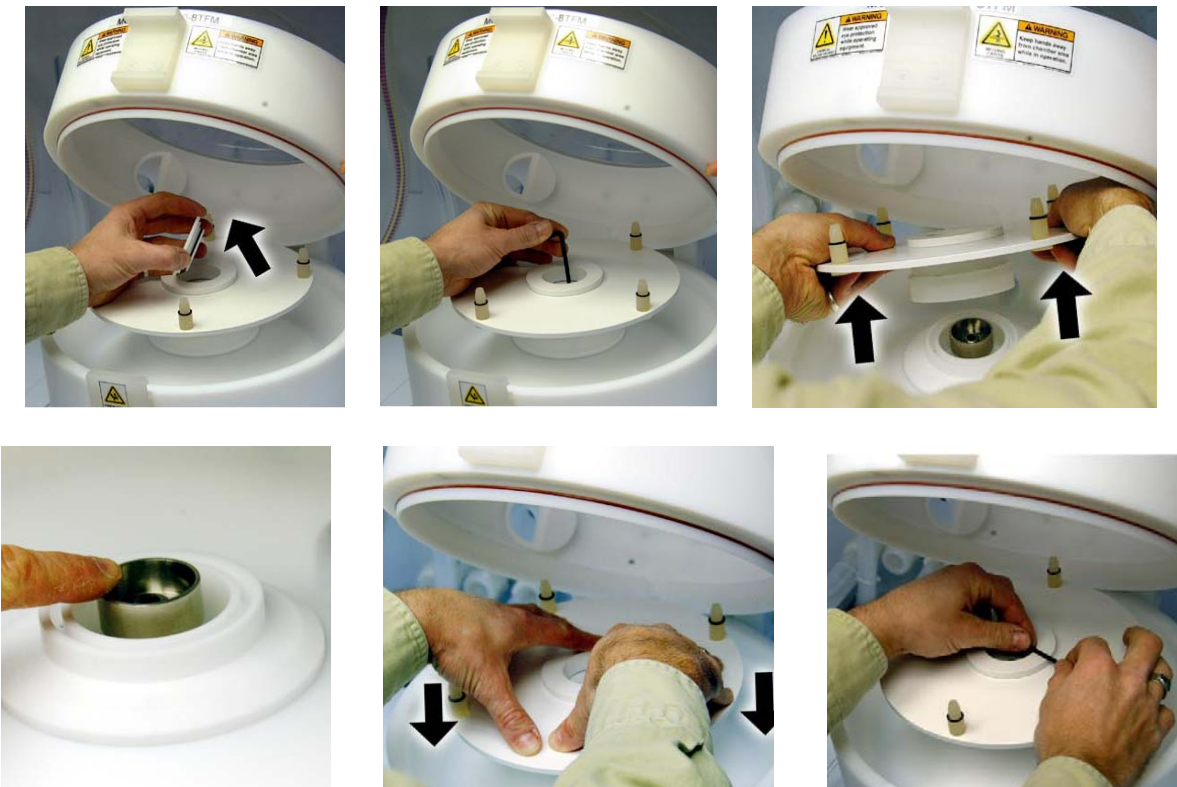

**Figure 3-14
REMOVING AND INSTALLING BOLT DOWN CHUCK**

SECTION 3.8 – SOFTWARE VERSION

The revision level of the software installed can be determined by powering the system off then on, or by simultaneously pressing the **DEL STEP** and **ADD STEP** keys while the unit is in the “off” mode (with the lid closed). The version will be displayed for four seconds on the display to the right of “rpm” Note: if “CDA” is flashing you will need to supply Nitrogen or CDA (>60 PSI of N₂ or Clean Dry Air) to the system before the software version is viewed (it shares the same part of the display).

SECTION 3.9 – HIGH PERFORMANCE DRIVE MOTOR (HPD2)

The HPD2 brushless motor is standard on our 15 series models and is optional with our other spin processors. All models equipped with a HPD2 motor have an additional lid interlock which prevents the opening of the lid while the tool is in operation. All HPD2 motors have an insert or bolt on type chuck (see section 3.7.2).

3.9.1 PROGRAMMING THE HPD2

The HPD2 uses the 400 controller and it is programmed in the same manner as our standard motor with a few exceptions.

- **ACCELERATION:** The HPD2 is capable of extremely fast acceleration rates up to 30,000 rpm/second. (Acceleration rates are greatly influenced by chuck load so individual cases may vary.) Acceleration is programmable from 2 to 30,000 rpm/sec.

CAUTION: When using a mechanical chuck always use low acceleration rates to prevent the possibility of throwing a substrate from the chuck!

- **SPIN SPEED:** The HPD2 spin speed is programmable with both positive and negative numbers. Positive numbers >+0001 will cause the motor to rotate counter clockwise and negative values <-0001 will cause clockwise rotation. Negative values can be entered by pressing the down arrow value key through 0 value. See figure 3-15



Figure 3-15
EXAMPLE OF NEGATIVE SPIN SPEED VALUE

➤ **PROCESSING TIP:** An agitation type program is possible when using both positive and negative spin speeds. The below example is meant to show how agitation programming is possible. Note this function will be available with WS-650 controller on or about 2/2005 – a retrofit is also possible – call or email our sales department for details if you need a continuous agitation mode for your work.

EXAMPLE OF AGITATION PROGRAMMING

Step	Time		Speed 0-6,000	Valves X=ON								Accel	Comment
	99	59.9		1	2	3	4	5	6	7	8		
	Min	Sec											
1		00.5	100	1	2	3	4	5	6	7	8	1000	
2		00.5	-100	1	2	3	4	5	6	7	8	1000	
3		00.5	100	1	2	3	4	5	6	7	8	1000	
4		00.5	-100	1	2	3	4	5	6	7	8	1000	
5		00.5	100	1	2	3	4	5	6	7	8	1000	
6		00.5	-100	1	2	3	4	5	6	7	8	1000	
7		00.5	100	1	2	3	4	5	6	7	8	1000	
8		00.5	-100	1	2	3	4	5	6	7	8	1000	
9		00.5	100	1	2	3	4	5	6	7	8	1000	
10		00.5	-100	1	2	3	4	5	6	7	8	1000	

SECTION 4 - MAINTENANCE

Generally there is very little maintenance required with our processors. Normal maintenance on the WS-400 Series spin processor is the cleaning the process bowl. It is recommended to clean the process bowl when processing is completed at the end of the day. Daily cleanup is a good practice and it prevents the excessive buildup of material over time. An appropriate solvent or cleaner should be used (wear all required personal protective equipment). It is recommended to leave the N₂/CDA supply on so that the seal purge is constantly present and to leave the lid in the up position to allow drying of residual moisture. Any questions regarding the maintenance of your spin processor can be addressed at www.support@laurell.com

- **Care should be taken not to flood the process chamber during cleaning.**
- If unit is equipped with a vacuum chuck, **it is important not to allow chemicals or chemical cleaners to enter the vacuum path.**
- **NEVER flood or spray solvent such as acetone or any other type of cleaner directly onto the keypad surface. Doing so may cause keypad failure. Always wet a wipe or cloth with the solvent and gently wipe the keypad surface.**

NOTE!

The vacuum path is not designed for any pressure. Air pressure or any liquid forced or drawn into the vacuum chuck will very likely damage the vacuum sensor, seals, motor and electronics. This type of damage is not covered by our warranty



- **CLEANING** - Clean, rinse, then dry your spin processor after each use, taking care to prevent any chemicals from entering the vacuum path. A good practice is to cover the chuck during bowl cleaning. This can be done with a wafer with vacuum turned on or use a cover such as Petri dish. **ALSO DO NOT FLOOD**

THE AREA BETWEEN THE STATIONARY SEAL AND THE ROTATING SEAL. THIS CAN CAUSE MOTOR OR ELECTRONICS DAMAGE. See Fig. 4-1 below. Do not fill up or overflow the process chamber or bowl – fluids must not be permitted to flow under the substrate. If the chuck face shows signs of chemical residue, remove and clean immediately. Cleaning the o-ring surface will improve the seal. Examine and adjust your process to prevent such occurrences. See section 4.1.3 Vacuum Chuck Wet Test

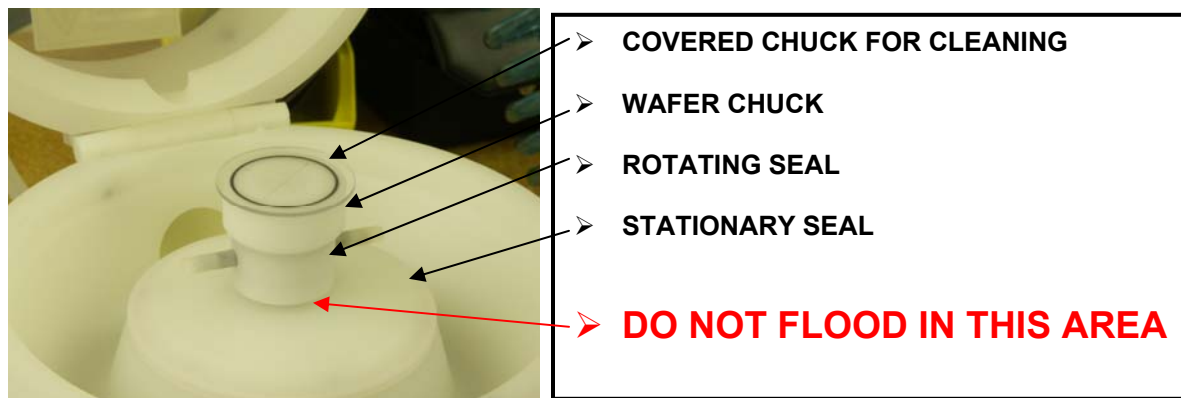

Figure 4-1

Do not at any time force fluids or pressuring gas in the center of the vacuum chuck. Cleaning the vacuum path in this manner is dangerous and can cause significant damage to your spin processor.

4.1 ERROR MESSAGES

The detection of abnormal operating conditions will cause the spin processor to shut down while in the process of running a program.

These conditions are:

- Inability of spin processor motor to maintain the programmed speed parameters.
- Detection of vacuum loss to the wafer in systems equipped with a vacuum sensor.

If either of these conditions occurs, the display will indicate the error status “**Exx**” in the “mode” area of the display. The specific error codes are listed below.

CODE	DESCRIPTION	ACTION
E02	RS-232 buffer overflow	Spin2000 only
E03	Motor speed control - Did not reach specified RPM	Shut down spin processor
E04	Vacuum below required minimum detected	Shut down spin processor
E05	Illegal command sent to spin processor from	Ignore, Spin2000 only

	Spin2000	
E06	A/D time out reading vacuum	Missed vacuum reading
E07	Motor exceeded maximum RPM	Shut down spin processor
E08	No RPM feedback. Zero RPM	Shut down spin processor, remove any restriction to rotation
E10	Purge Air pressure below setpoint. Will not start new process. Will shut down spin processor	Check "Seal Purge" hookup and pressure (SEC 3.2.3)

Certain errors will cause the motor to shut down. The timer will stop. Pressing the **F1** key clears errors and pressing the **RUN** key will restart the program at the point it was shut down. If you desire to restart the program from the beginning, press the **F1** key twice, then press the **RUN** key to start.

If an error condition occurs, check the following:

- Record the time, conditions, program number, program step, and error code
- Determine if error is due to vacuum loss or motor speed. Correct any obvious problems
- If condition persists, contact Support at Laurell Technologies Corporation for assistance
- Vacuum source
- Seal Purge source pressure >60 PSI required
- Lock out power supply and turn chuck by hand making note of any excessive drag

Note: Mechanical intervention during rotation is not permitted with this equipment design and damage caused is not covered by our warranty.

4.1.1 VACUUM LOSS (On units equipped with vacuum sensor only.)

- Vacuum readings >20" Hg typically indicate sufficient vacuum hold is present. <15" Hg vacuum (factory setpoint) is normally considered insufficient to operate safely. A flashing "V=XX" display is an insufficient vacuum indicator where XX is the actual vacuum value being read by sensor.

Note: the vacuum setpoint can be changed (contact the factory for the adjustment procedure)

4.1.2 REMOVING, CLEANING AND INSTALLING THE VACUUM VALVE

- The vacuum valve is an air operated valve with an internal piston. Chemicals such as photoresist or polyimides, which enter into the vacuum path, can prevent this piston from moving. The piston will fail to operate due to chemical contamination. If this happens and it is obvious that the vacuum valve is not

functioning properly, the following procedure can be performed to clean the valve.

- **NOTE: FOLLOW THIS PROCEDURE CLOSELY AND BE CAREFULL NOT TO LOSE THE 3 SMALL O-RINGS!**



1 - Carefully remove the 4 socket head screws.



2 - Lift the 3 piece assembly away from the spinner using great care not to lose the small face o-ring.

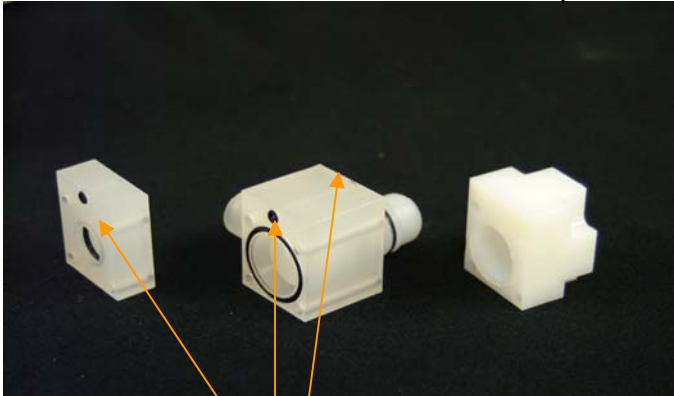

3 - The main assembly consists of 3 pieces and 3 small o-rings

Small o-rings

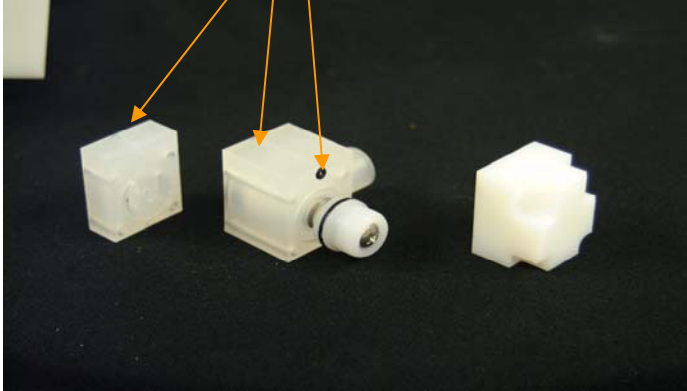

Backside view of the 3 piece assembly



It is not always necessary to disassemble the valve for cleaning. The valve can be soaked as a whole unit.

4 - If you decide to disassemble the valve, first remove the bell screw.

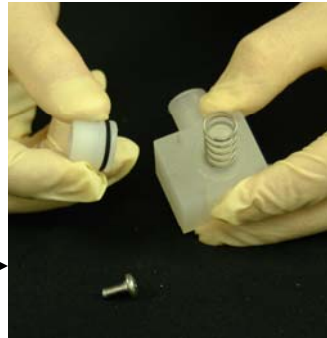

5 - After removing the screw lift off the bell and the actuation spring.

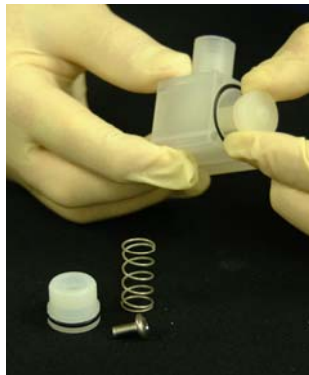

6 - Remove the piston by carefully sliding it out of the center assembly.

Keep track of all parts while cleaning, so as not to lose any for reassembly.



The parts can be taken apart and hand cleaned or soaked in an Acetone bath.

Never scrape the parts when cleaning! This will degrade the tolerances needed for proper operation.



7 - Reassemble the center valve assembly in the same order that the valve was disassembled. If any o-rings or parts appear degraded, contact the factory.



8 - Take the first section and carefully snap into vacuum face groove, making sure that the o ring stays fully seated.

Vacuum Face Groove

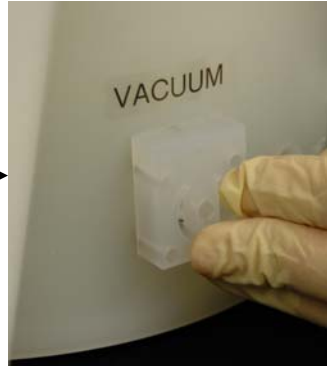

9 - Hold first section into groove and attach the two other sections.

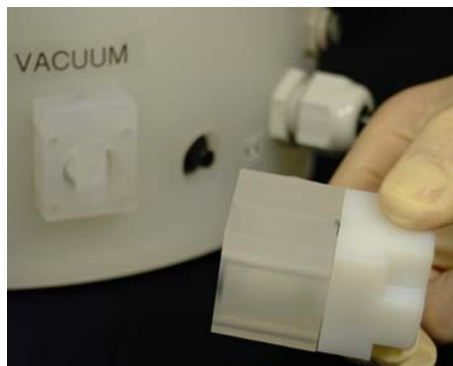

10 - Press the two remaining sections onto the first section, also making sure that the o-rings are firmly in place.

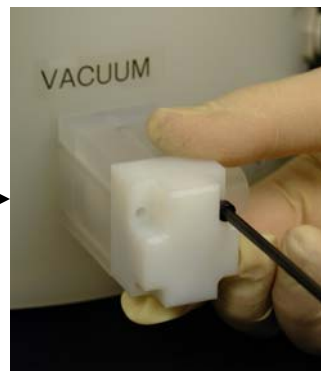

11 - With the entire assembly in tact, insert the first screw.



12 - Insert each screw loosely. **DO NOT** totally tighten until all four screws have been inserted.



13 - Tighten screws firmly, but do not over tighten. When tightening the screws, work in a criss-cross pattern.

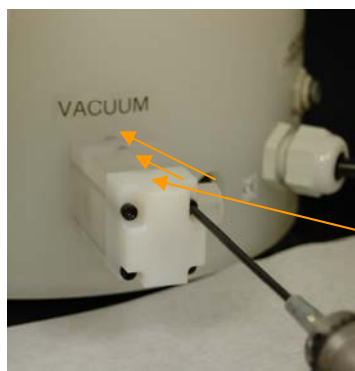

14 - Make sure screws are secure, but not over tightened.
Also check to see if all o-rings are in place.

4.1.3 VACUUM CHUCK WET TEST

- To prevent chemicals from entering into the vacuum path, the chuck and o-ring surface must be clean and defect free. A chuck wet test can be performed to check the integrity of the o-ring seal. See Fig.4-2. Using a clear substrate, place the wafer on the chuck and press the vacuum key. Using a bottle of DI water spray water around the periphery of the substrate where it meets the chuck while manually rotating the chuck. Check to see if there is any leakage across the o-ring.
 - If there is no leakage, the chuck is ok to use.

- If leakage occurs, inspect the chuck and o-ring for defects. If the chuck is damaged it is recommended that it is replaced with a new Laurell chuck. If the chuck is defect free, wipe the chuck and o-ring surface with DI water or an appropriate cleaner. The cleaning solution or solvent must be compatible with the o-ring material. Repeat wet test. If wiping down the chuck and o-ring fails to prevent leakage remove and clean the o-ring. See section 4.1.4.



Figure 4-2
Wet Testing 1.75" and 200mm Chuck

4.1.4 CLEANING AND REPLACING THE CHUCK O-RING

- To remove the o-ring from the chuck, insert a thin blunt instrument or o-ring puller into the o-ring groove and pull upward. Be careful not to damage the o-ring or chuck. Inspect the o-ring carefully. If the o-ring is cut, nicked or scratched it must be replaced. Contact Laurell for part number and ordering information. If the o-ring is in good condition, wipe it with a cleaner and insert it back into the o-ring groove. Use the following procedure to insert the o-ring.



1 - Carefully press the o-ring into the chuck face groove. Do so by pressing in a small section at a time.

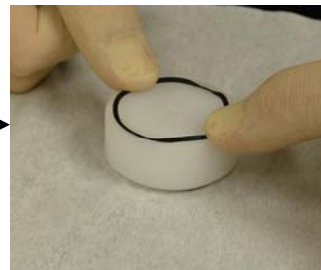

2 - After the small sections have been pressed in, carefully press around the chuck until the o-ring is fully seated.

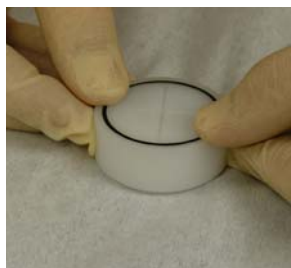

3 - The o-ring should lay flat in the groove.

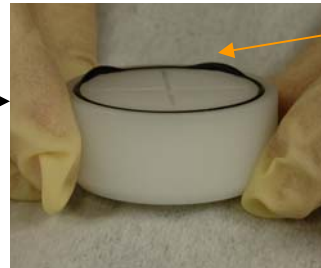

4 - There should not be any areas that do not lay flat. If this occurs, continue to press around the chuck until they are gone.



5 - Make a final check to be sure that the o-ring is entirely seated. Perform a chuck wet test to ensure o-ring sealing integrity.

4.1.4.1 O-RING COMPOSITION, USES & RECOGNITION

- The installed chuck o-ring is dependent upon the chemicals that are specified in the sales order. EPDM rings are most commonly used for solvent based chemicals, while Viton o-rings are used for acids as well as Toluene. Depending on chuck design and system configuration some models are shipped with both EPDM and Viton o-rings.
- In the event that the EPDM and Viton o-rings become intermixed, an EPDM o-ring can usually be identified by the more rigid feel as opposed to the Viton o-ring, which has a smooth texture. Some Viton o-rings are brown in color.
- When using the fragment adapter it is important to note that only one o-ring should be used at any one time. Two o-rings are never to be used at the same time on the fragment chuck. When two o-rings are used simultaneously, an improper seal may develop allowing chemical to enter the vacuum path. The size o-ring to be used is determined by the size of the substrate being used. **Important:** The substrate must always fully cover the face of the o-ring to prevent chemical leakage into the vacuum path.

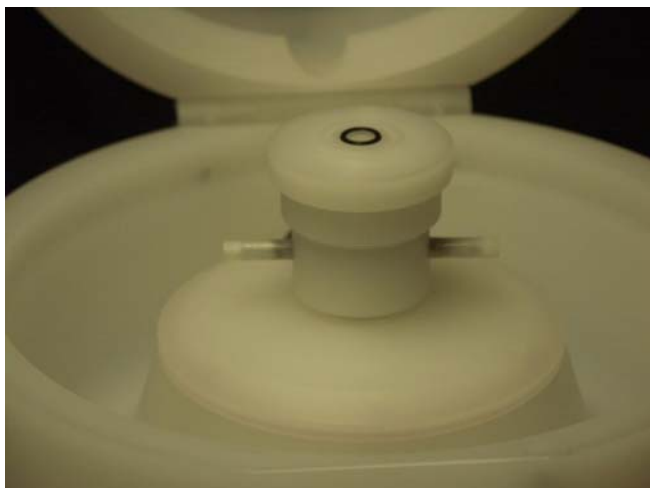

- The fragment adapter must be installed with a single o-ring for fragments.
- The inside o-ring is for fragments $\geq 11\text{mm} \times 11\text{mm}$.
- The outside o-ring is for fragments $\geq 20\text{mm} \times 20\text{mm}$.
- Only 1 size o-ring should be installed in the adapter at any one time.

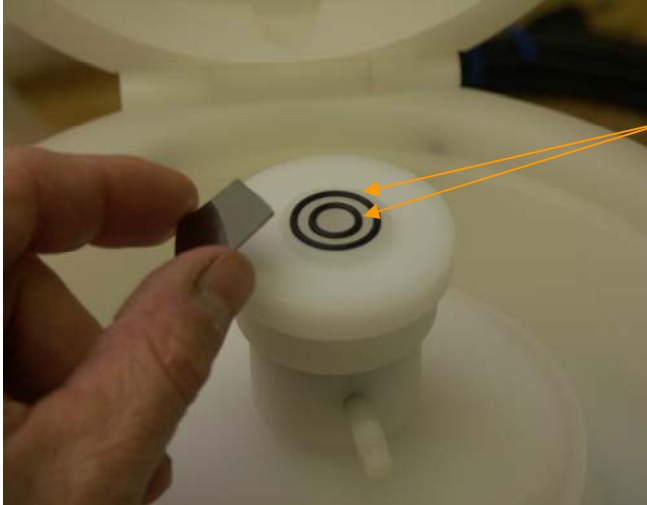

➤ Improper installation of two simultaneous o-rings on the fragment adapter.

4.1.5 MOTOR OPERATION

- Manually turn chuck and check for free movement and no binding. The motor should never be overloaded or held from turning.
- If RPM display shows zeroes when the chuck is actually spinning, this would indicate failure of the RPM sensor and an E08 error will appear.
- Deceleration of the motor from a high speed is usually far less controllable than acceleration. When programming such steps, it is necessary to select a deceleration rate that the motor can achieve. This usually requires setting the acceleration index in the 1 to 5 range. If this is not done the momentum of the chuck and motor will not allow the speed to follow the required motor speed profile, causing an error. If this occurs, decrease the acceleration index in the program step that goes to the lower speed. See Section 3.5.1 “PROGRAMMING ACCELERATION/DECELERATION” of this manual for details.

4.1.6 CALIBRATION MODE

Calibration is used to adjust rotation performance by allowing fine-tuning of the motor controller for large changes in chuck and substrate mass, as well as motor efficiency corrections in time. This is performed at the factory and is normally not required again.

NOTE: Contact the factory for detailed instruction

SECTION 5 – APPENDIX

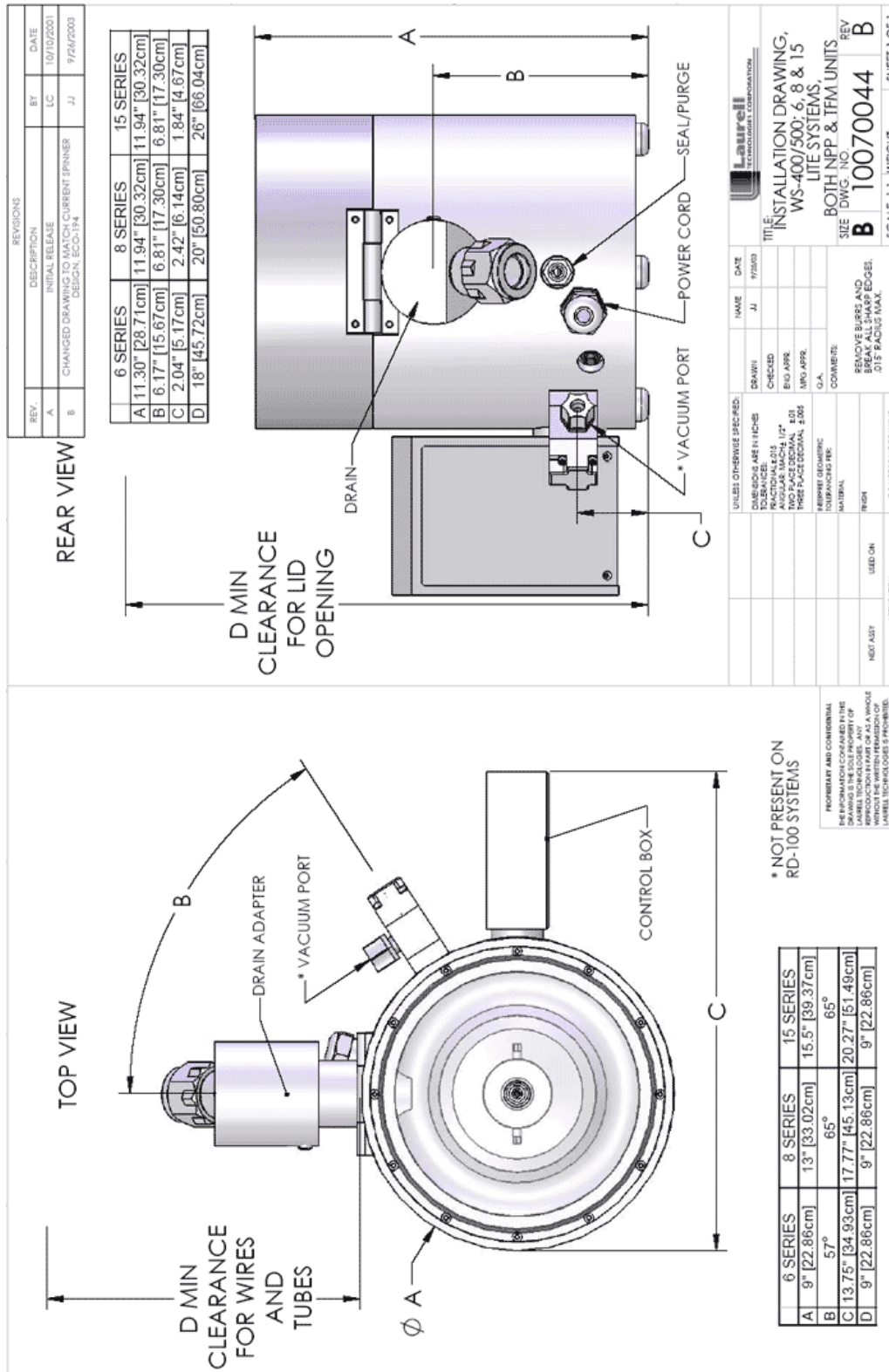

**Figure 5-1-1
INSTALLATION WS-400 6&8 LITE**

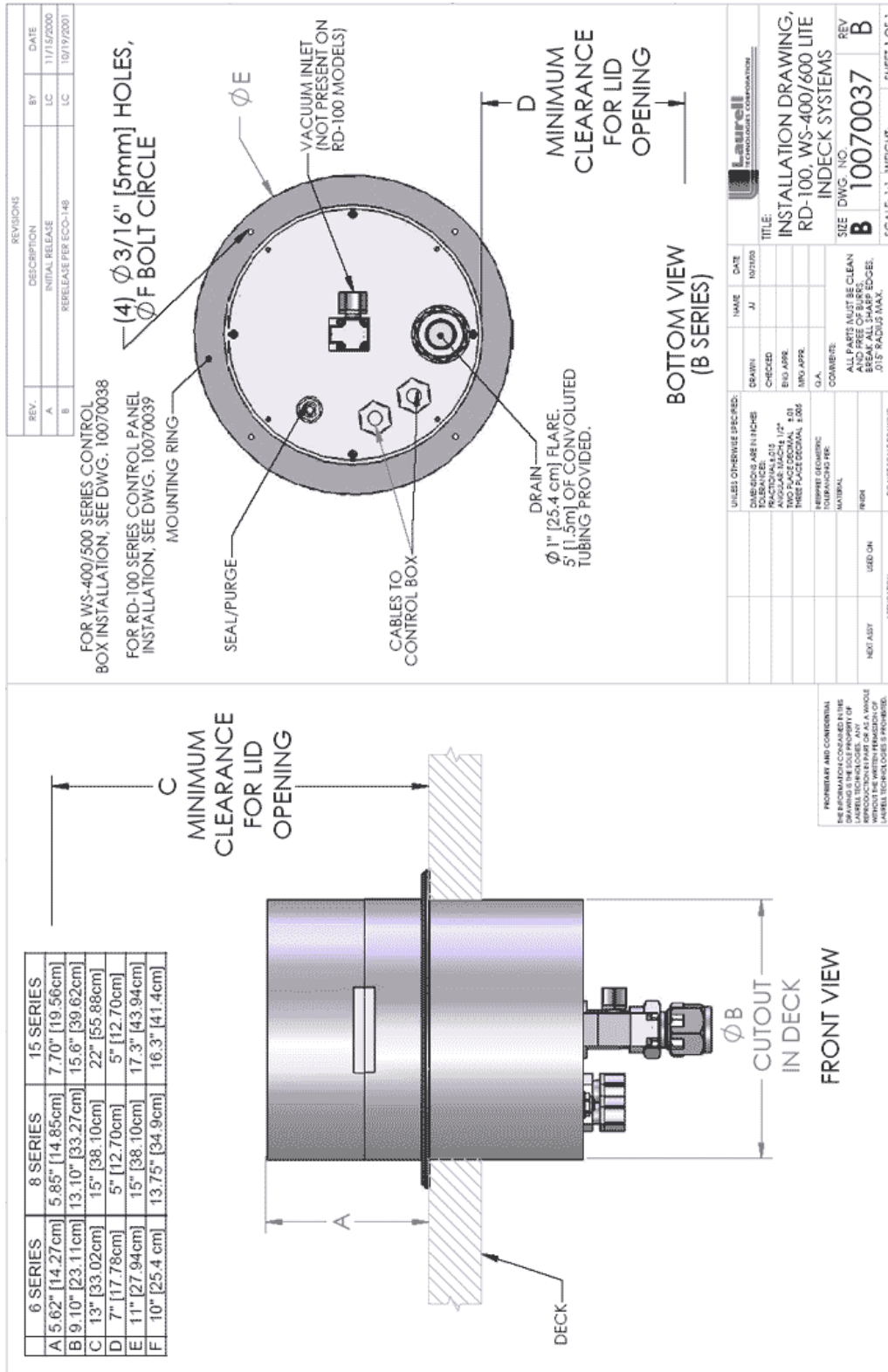

**Figure 5-1-2
 INSTALLATION RD-100, WS-400 LITE INDECK**

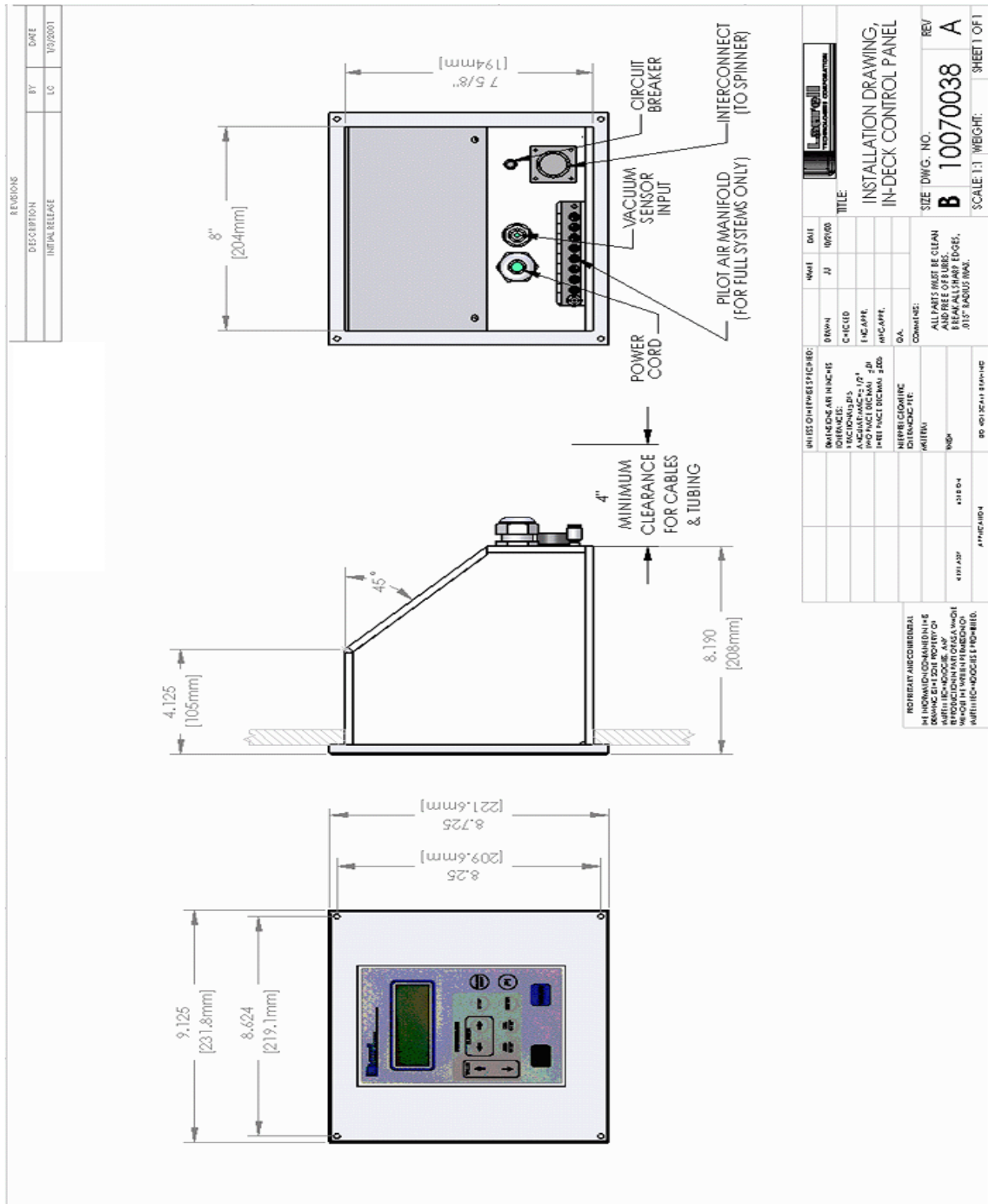

Figure 5-1-3
 INSTALLATION IN-DECK CONTROL PANEL

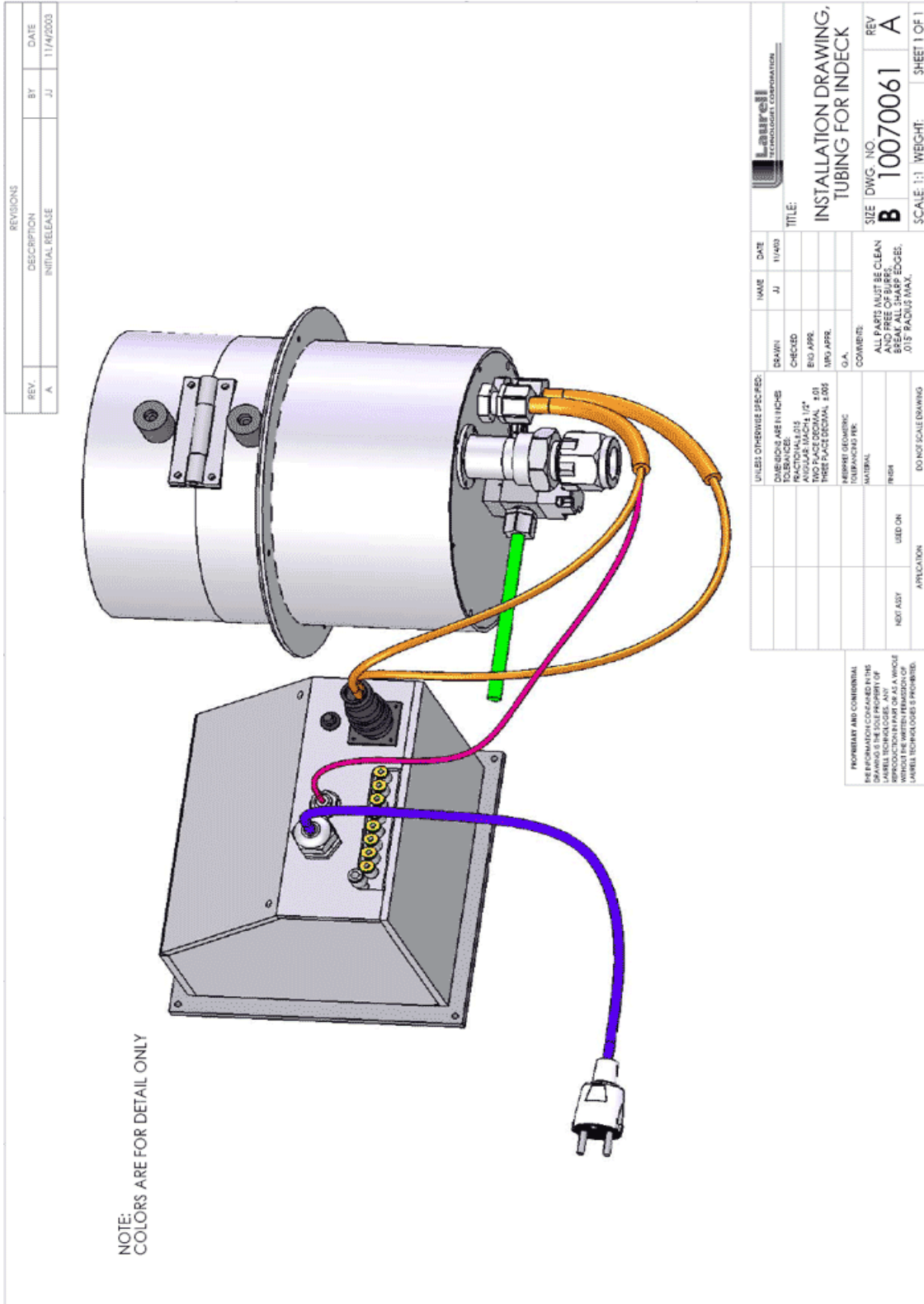

Figure 5-1-4
INSTALLATION TUBING FOR INDECK
 (shown with pilot air valves for Full systems only)

AVAILABLE OPTIONS

- Vacuum pump
- Adjustable down-flow exhaust and drain with differential pressure gauge
- Clear polycarbonate wafers – many sizes available
- Custom vacuum non-vacuum chucks
- Manual syringe kit
- Manual EBR syringe
- High performance drive motors
- Higher speed – up to 10,000 RPM

Conversions Available (factory installed only)

- Drain diverter
- Programmable exhaust
- Automatic syringe dispense
- Programmable dynamic linear or rotary dispense arm
- Spray and flood injectors
- Automatic EBR (Edge Bead Removal)
- Backside or simultaneous top & bottom dispense
- ESD controller

Note: Some options not available for all models.

Contact Sales@Laurell.com for more information.